

Overview

HPE ProLiant ML350 Gen10 Server

Driving a wide range of workloads with a flexible, shorter and rackable chassis design that can fit in different physical environments, the secure 2P HPE ProLiant ML350 Gen10 Server delivers the ideal set of performance and expandability for changing business needs making it the choice for growing SMBs, remote/branch offices of large enterprises and data centers. Choose this 2P tower that grows with you in the digital economy.

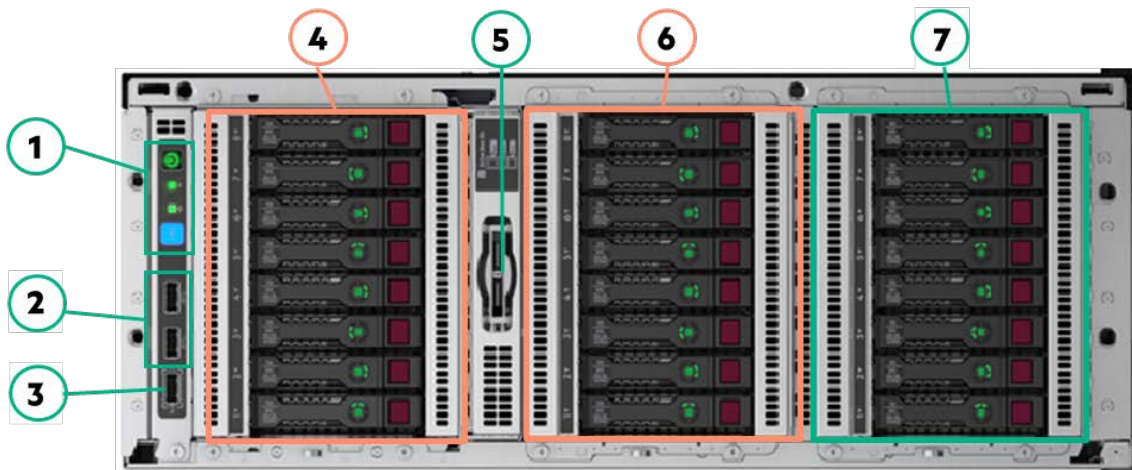

Front View – SFF chassis with optional Gen10 8SFF HDD Cage Kits shown (Rack mode)

1. Front button/LED (top-to-down in Rack mode shown): Power On/Stand-by button and System Power LED, System Health LED, NIC Status LED, UID Button/LED
2. USB 3.0 port x 2
3. iLO Service Port
4. Box1: optional HDD Drive Cage Bay for additional 8 SFF drives support, or upgradeable to 2 HH media devices + 1 slim-line DVD.
5. Serial number/iLO information pull tab
6. Box2: optional HDD Drive Cage Bay for additional 8 SFF drives support, or upgradeable to 8 SFF NVMe Express Bay
7. Box3: default with one 8 SFF HDD Drive Cage

NOTE: Image shown without the security front bezel which is standard in every ML350 Gen10 unit.

Overview

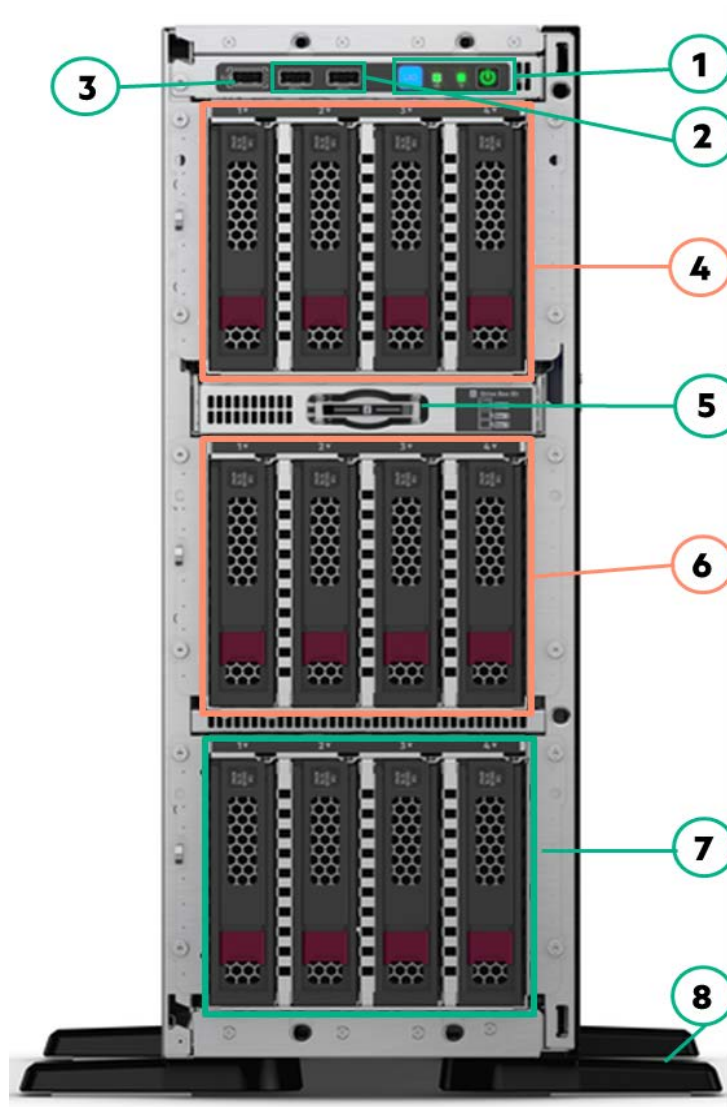

Front View – LFF chassis with optional Gen10 4LFF HDD Cage Kits shown (Tower mode)

- | | |
|--|--|
| 1. Front button/LED (right-to-left in Tower mode shown):
Power On/Stand-by button and System Power LED, System Health LED, NIC Status LED, UID Button/LED | 2. USB 3.0 port x 2 |
| 3. iLO Service Port | 4. Box1: optional HDD Drive Cage Bay for additional 4 LFF drives support, or upgradeable to 2 HH media devices + 1 slim-line DVD |
| 5. Serial number/iLO information pull tab | 6. Box2: optional HDD Drive Cage Bay for additional 4 LFF drives support |
| 7. Box3: default with one 4LFF HDD Drive Cage | 8. Tower feet (foldable at servicing) |

NOTE: For NHP LFF chassis, please find detail in the [ML350 Gen10 User Guide](#).

NOTE: Image shown without the security front bezel which is standard in every ML350 Gen10 unit.

Overview

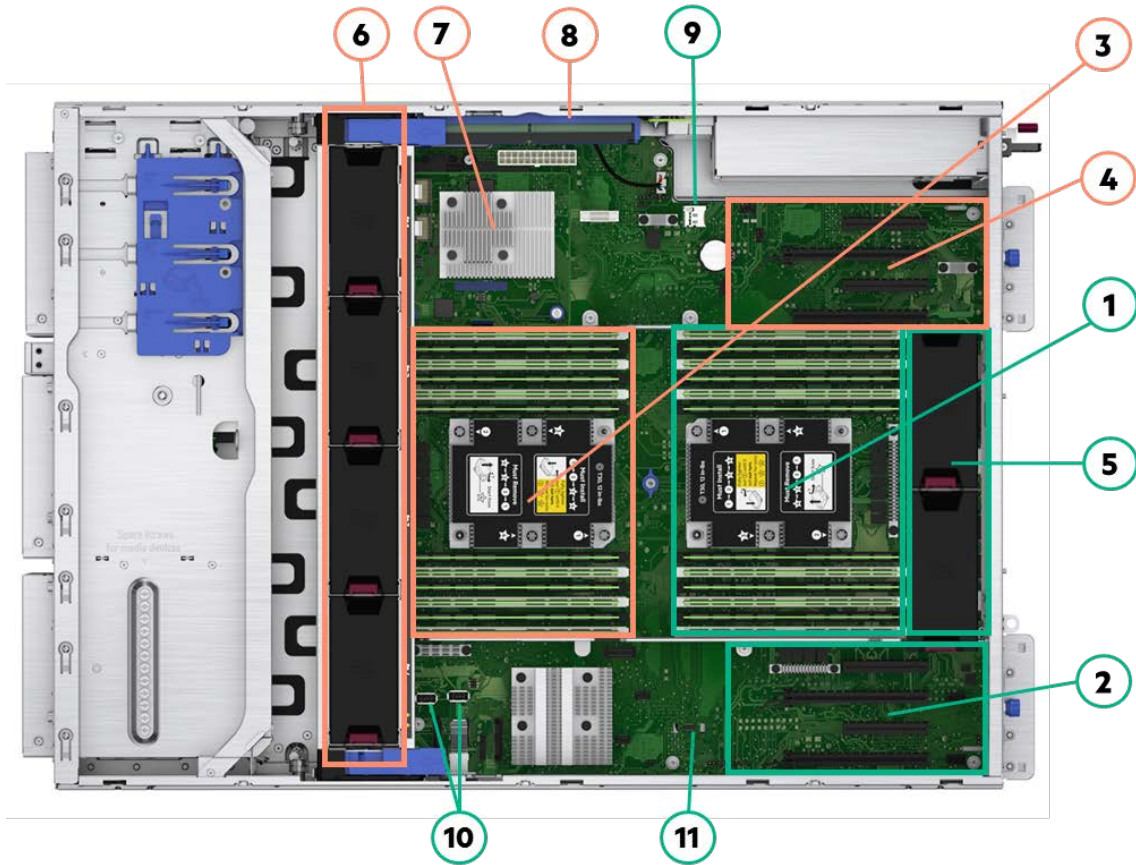
Internal View – with optional 2nd CPU, Smart Array Modular Controller and Redundant Fan Kit shown

- | | |
|--|---|
| 1. CPU Socket 1 with one processor and heatsink, and 12 DDR4 DIMM slots for RDIMM or LRDIMM | 2. PCIe Slots (Slot 1-4, coming from CPU1): Slot 1 and 3 can support Optional GPU |
| 3. CPU Socket 2 with the 2 nd processor and heatsink, (depending on server model, the 2 nd processor can be Optional) and 12 DDR4 DIMM slots for RDIMM or LRDIMM | 4. PCIe Slots (Slot 5-8, coming from CPU2) (requires Optional 2 nd processor): Slot 5 and 7 can support Optional GPU |
| 5. System fans: (2) fans along with the air baffle (not shown) are standard for basic cooling | 6. Optional (4) system fans are shown, supporting 2P and/or advanced cooling requirements. |
| 7. Optional HPE Smart Array Modular controller (AROC) | 8. Optional HPE Smart Storage Battery |
| 9. MicroSD Slot x1 | 10. Internal USB port x2 (USB3.0 x1 and USB2.0 x1) |
| 11. TPM Connector | |

Overview

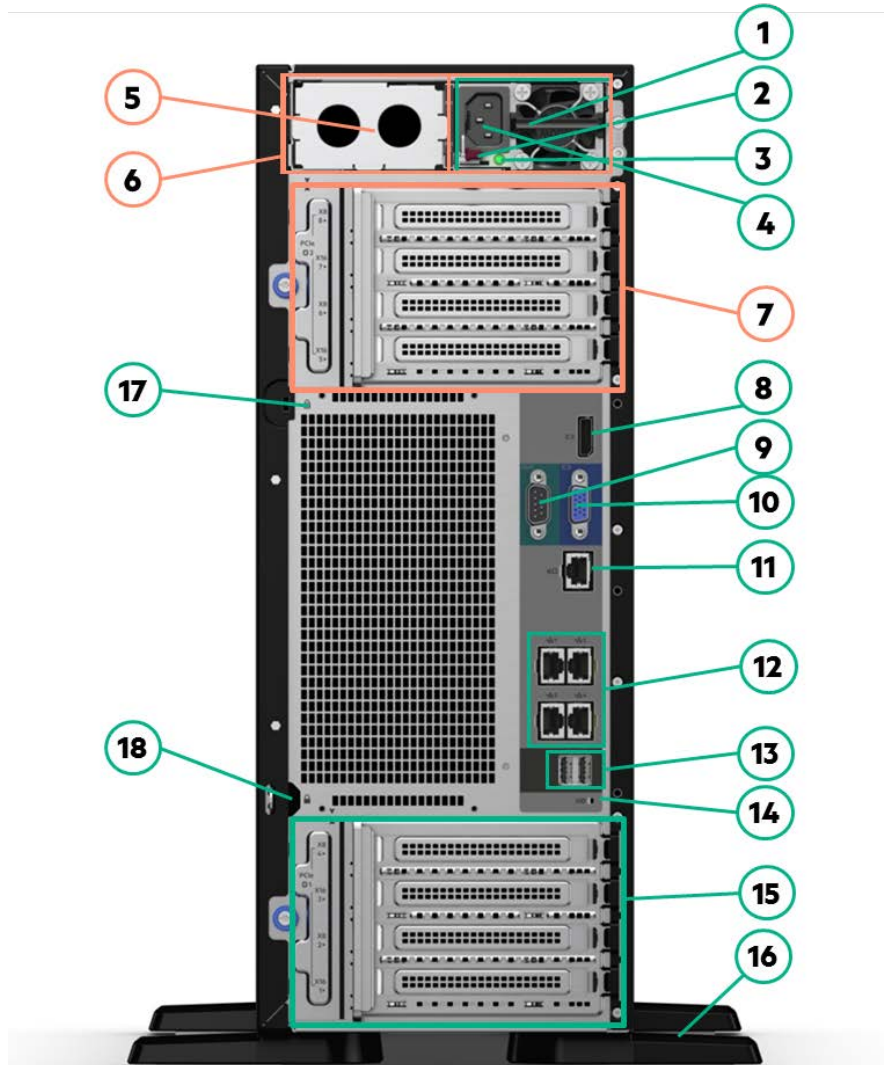
**Rear View – With HPE Flex Slot RPS shown.**

- | | |
|---|--|
| 1. HPE Flexible Slot 1 Power Supply | 2. Power supply handle (with red touch-point) |
| 3. Power supply Power LED | 4. Power supply Power connection |
| 5. HPE Flexible Slot 2 (Optional – empty with power supply blank shown) | 6. Or, support for HPE 500W Standard Non-Hot-Plug/non-RPS Power Supply, depending on model SKU |
| 7. PCI Slots (Slots 5-8) (requires Optional second processor) – Slot 5 and 7 can support Optional GPU | 8. Display Port |
| 9. Serial Port | 10. VGA Port |
| 11. Dedicated iLO Management Port (RJ45) | 12. Embedded 4 x 1GbE Network ports |
| 13. USB 3.0 port x 2 | 14. Unit ID LED |
| 15. PCI Slots (Slots 1-4) – Slot 1 and 3 can support Optional GPU | 16. Tower feet (foldable at servicing) |
| 17. Kensington security slot | 18. Padlock eye |

Overview

What's New:

- Support of the HPE NVidia Quadro GV100 GPU module and the new NVLink Bridge powering the AI Tower Server with high-speed GPU connection, ray-tracing and AI

Platform Information

Form Factor

4U tower with rack conversion capability

NOTE: When deployed as a Rack model, this system will take up 5U-height space in a standard data center rack facility.

Chassis Types

8 SFF chassis with optional SFF HDD cage kit (s), NVMe Express Bay, half-height (5.25") media bay up to 2, and 1 slim-line DVD bay kit options

4 LFF chassis with optional LFF HDD cage kit (s), half-height (5.25") media bay up to 2, and 1 slim-line DVD bay kit options

4 LFF NHP chassis with optional LFF NHP HDD cage kit (s), half-height (5.25") media bay up to 2, and 1 slim-line DVD bay kit options

NOTE: The 8 SFF chassis can be upgraded with SFF HDD cage kit (s) to 16 or 24 SFF. Note a field upgrade to 24 SFF will require redundant fan kit (874572-B21).

NOTE: The 8 SFF NVMe Express Bay option (874569-B21) can only be leveraged in the SFF chassis and installed in Box 2. Maximum of 8 SFF NVMe PCIe drives are supported when two ML350 Gen10 NVMe Riser boards (shipped in 874569-B21) are populated. When only one Riser board is populated, then 4 NVMe drives are supported. Note a field upgrade to NVMe Express Bay will require redundant fan kit (874572-B21).

NOTE: The 4 LFF HP or NHP chassis can be upgraded with LFF HDD cage kit (s) or LFF NHP HDD cage kit (s) to 8 or 12 LFF. Note a field upgrade to 12 LFF either in LFF hot-plug or LFF non-hot-plug chassis will require redundant fan kit (874572-B21).

NOTE: The 8 SFF or 4 LFF or 4 LFF NHP chassis can be upgraded to add half-height media bay up to 2, and/or 1 slim-line DVD in Box1. Note a field upgrade to fully populate front storage bays (Box1, 2 and 3 fully loaded) will require redundant fan kit (874572-B21).

System Fans

Standard – fan types included

NOTE: 1P models typically ship with 2 standard fans located at system rear. These two fans are default inside every ML350 Gen10 unit and do NOT support hot-plug operations.

NOTE: 2P models typically ship with 6 standard fans which provides N+1 redundant fan feature in most of the situations. For support detail or restriction, refer to ML350 Gen10 User Guide.

NOTE: Optional redundant fan kit (874572-B21) provides advanced cooling and redundancy functionality in heavier configurations. Configurations that require this kit are provided in later sections. Refer to the User Guide for special configuration scenarios where this kit is required but does not provide redundancy feature.

Standard Features

Processors – Up to 2 of the following depending on model.

NOTE: For more information regarding Intel Xeon processors, please see the following <http://www.intel.com/xeon>.

Intel Xeon Models	CPU Frequency	Cores	L3 Cache	Power	UPI	DDR4	Memory per socket
Platinum Processors							
Platinum 8180M Processor	2.5 GHz	28	38.50 MB	205W	3 @ 10.4 GT/s	2666 MT/s	1.5 TB
Platinum 8180 Processor	2.5 GHz	28	38.50 MB	205W	3 @ 10.4 GT/s	2666 MT/s	768 GB
Platinum 8176M Processor	2.1 GHz	28	38.50 MB	165W	3 @ 10.4 GT/s	2666 MT/s	1.5 TB
Platinum 8176 Processor	2.1 GHz	28	38.50 MB	165W	3 @ 10.4 GT/s	2666 MT/s	768 GB
Platinum 8170M Processor	2.1 GHz	26	35.75 MB	165W	3 @ 10.4 GT/s	2666 MT/s	1.5 TB
Platinum 8170 Processor	2.1 GHz	26	35.75 MB	165W	3 @ 10.4 GT/s	2666 MT/s	768 GB
Platinum 8168 Processor	2.7 GHz	24	33.00 MB	205W	3 @ 10.4 GT/s	2666 MT/s	768 GB
Platinum 8164 Processor	2.0 GHz	26	35.75 MB	150W	3 @ 10.4 GT/s	2666 MT/s	768 GB
Platinum 8160M Processor	2.1 GHz	24	33.00 MB	150W	3 @ 10.4 GT/s	2666 MT/s	1.5 TB
Platinum 8160 Processor	2.1 GHz	24	33.00 MB	150W	3 @ 10.4 GT/s	2666 MT/s	768 GB
Platinum 8158 Processor	3.0 GHz	12	24.75 MB	150W	3 @ 10.4 GT/s	2666 MT/s	768 GB
Platinum 8156 Processor	3.6 GHz	4	16.50 MB	105W	3 @ 10.4 GT/s	2666 MT/s	768 GB
Platinum 8153 Processor	2.0 GHz	16	22.00 MB	125W	3 @ 10.4 GT/s	2666 MT/s	768 GB
Gold Processors							
Gold 6154 Processor	3.0 GHz	18	24.75 MB	200W	3 @ 10.4 GT/s	2666 MT/s	768 GB
Gold 6152 Processor	2.1 GHz	22	30.25 MB	140W	3 @ 10.4 GT/s	2666 MT/s	768 GB
Gold 6150 Processor	2.7 GHz	18	24.75 MB	165W	3 @ 10.4 GT/s	2666 MT/s	768 GB
Gold 6148 Processor	2.4 GHz	20	27.50 MB	150W	3 @ 10.4 GT/s	2666 MT/s	768 GB
Gold 6146 Processor	3.2 GHz	12	24.75 MB	165W	3 @ 10.4 GT/s	2666 MT/s	768 GB
Gold 6144 Processor	3.5 GHz	8	24.75 MB	150W	3 @ 10.4 GT/s	2666 MT/s	768 GB
Gold 6142M Processor	2.6 GHz	16	22.00 MB	150W	3 @ 10.4 GT/s	2666 MT/s	1.5 TB
Gold 6142 Processor	2.6 GHz	16	22.00 MB	150W	3 @ 10.4 GT/s	2666 MT/s	768 GB
Gold 6140M Processor	2.3 GHz	18	24.75 MB	140W	3 @ 10.4 GT/s	2666 MT/s	1.5 TB
Gold 6140 Processor	2.3 GHz	18	24.75 MB	140W	3 @ 10.4 GT/s	2666 MT/s	768 GB
Gold 6138 Processor	2.0 GHz	20	27.50 MB	125W	3 @ 10.4 GT/s	2666 MT/s	768 GB
Gold 6136 Processor	3.0 GHz	12	24.75 MB	150W	3 @ 10.4 GT/s	2666 MT/s	768 GB
Gold 6134M Processor	3.2 GHz	8	24.75 MB	130W	3 @ 10.4 GT/s	2666 MT/s	1.5 TB
Gold 6134 Processor	3.2 GHz	8	24.75 MB	130W	3 @ 10.4 GT/s	2666 MT/s	768 GB
Gold 6132 Processor	2.6 GHz	14	19.25 MB	140W	3 @ 10.4 GT/s	2666 MT/s	768 GB
Gold 6130 Processor	2.1 GHz	16	22.00 MB	125W	3 @ 10.4 GT/s	2666 MT/s	768 GB
Gold 6128 Processor	3.4 GHz	6	19.25 MB	115W	3 @ 10.4 GT/s	2666 MT/s	768 GB
Gold 6126 Processor	2.6 GHz	12	19.25 MB	125W	3 @ 10.4 GT/s	2666 MT/s	768 GB
Gold 5122 Processor	3.6 GHz	4	16.50 MB	105W	2 @ 10.4 GT/s	2666 MT/s	768 GB
Gold 5120 Processor	2.2 GHz	14	19.25 MB	105W	2 @ 10.4 GT/s	2400 MT/s	768 GB
Gold 5118 Processor	2.3 GHz	12	16.50 MB	105W	2 @ 10.4 GT/s	2400 MT/s	768 GB
Gold 5115 Processor	2.4 GHz	10	13.75 MB	85W	2 @ 10.4 GT/s	2400 MT/s	768 GB

Standard Features

Silver Processors							
Silver 4116 Processor	2.1 GHz	12	16.50 MB	85W	2 @ 9.6 GT/s	2400 MT/s	768 GB
Silver 4114 Processor	2.2 GHz	10	13.75 MB	85W	2 @ 9.6 GT/s	2400 MT/s	768 GB
Silver 4112 Processor	2.6 GHz	4	8.25 MB	85W	2 @ 9.6 GT/s	2400 MT/s	768 GB
Silver 4110 Processor	2.1 GHz	8	11.00 MB	85W	2 @ 9.6 GT/s	2400 MT/s	768 GB
Silver 4108 Processor	1.8 GHz	8	11.00 MB	85W	2 @ 9.6 GT/s	2400 MT/s	768 GB
Bronze Processors							
Bronze 3106 Processor	1.7 GHz	8	11.00 MB	85W	2 @ 9.6 GT/s	2133 MT/s	768 GB
Bronze 3104 Processor	1.7 GHz	6	11.00 MB	85W	2 @ 9.6 GT/s	2133 MT/s	768 GB

NOTE: Platinum – 8100 Series – 2 Socket supports 2UPI, supports 6-Channel DDR4 @ 2666 MT/s providing up to 768 GB memory capacity (1.5 TB on select processor skus). Intel Turbo Boost Technology, Intel Hyper-Threading Technology supported. Intel AVX-512 (2x 512-bit FMA), 48 lanes PCIe 3.0, advanced RAS.

NOTE: Gold – 5100, 6100 Series - 2 Socket supports 2UPI, supports 6-Channel DDR4 @ 2400 MHz (SKU 5122=supports 2666) providing up to 768GB memory capacity (1.5 TB on select skus). Intel Turbo Boost Technology, Intel Hyper-Threading Technology, Intel AVX-512(1x 512-bit FMA) (SKU 5122 supports 2x 512 bit FMA), 48 lanes PCIe 3.0, advanced RAS supported.

NOTE: Silver – 4100 Series - 2 Socket supports 2UPI @ 9.6 GT/s, 6-Channel DDR4 @ 2400 MHz providing up to 768 GB memory capacity. Intel Turbo Boost Technology, Intel Hyper-Threading Technology, Intel AVX-512(1x 512-bit FMA), 48 lanes PCIe 3.0, standard RAS supported.

NOTE: Bronze – 3100 Series - 2 Socket supports 2UPI @ 9.6 GT/s, supports 6-Channel DDR4 @ 2133 MHz providing up to 768GB memory capacity. Intel AVX-512(1x 512-bit FMA), 48 lanes PCIe 3.0, standard RAS supported.

Chipset

Intel C622 Chipset

NOTE: For more information regarding Intel® chipsets, please see the following

URL: <http://www.intel.com/products/server/chipsets/>

On System Management Chipset

HPE iLO 5 ASIC

NOTE: Read and learn more in the [iLO QuickSpecs](#).

Memory

One of the following depending on model

Type:		HPE DDR4 SmartMemory, Registered (RDIMM), Load Reduced (LRDIMM)
DIMM Slots Available	24	12 DIMM slots per processor, 6 channels per processor, 2 DIMMs per channel
Maximum capacity (LRDIMM)	3 TB	24 x 128 GB LRDIMM @ 2600 MT/s
Maximum capacity (RDIMM)	768 GB	24 x 32 GB RDIMM @ 2600 MT/s

NOTE: The maximum memory by socket is limited by the processor selection.

NOTE: Mixing of RDIMM and LRDIMM memory is not supported.

Memory Protection

For details on the HPE Server Memory Options RAS feature, visit: <http://www.hpe.com/docs/memory-ras-feature>.

Standard Features

Expansion Slots

Slots #	Technology	Bus Width	Connector Width	Slot Form Factor	Notes
1	PCIe 3.0	X16	X16	Full-height, full-length slot	Proc 1
2	PCIe 3.0	X4	X8	Full-height, full-length slot	Proc 1
3	PCIe 3.0	X16	X16	Full-height, full-length slot	Proc 1
4	PCIe 3.0	X4	X8	Full-height, full-length slot	Proc 1

NOTE: Bus Width Indicates the number of physical electrical lanes running to the connector.

NOTE: Slot 4 is routed from the PCH.

Slots #	Technology	Bus Width	Connector Width	Slot Form Factor	Notes
5	PCIe 3.0	X16	X16	Full-height, full-length slot	Proc 2
6	PCIe 3.0	X8	X8	Full-height, full-length slot	Proc 2
7	PCIe 3.0	X16	X16	Full-height, full-length slot	Proc 2
8	PCIe 3.0	X8	X8	Full-height, full-length slot	Proc 2

NOTE: Bus Width Indicates the number of physical electrical lanes running to the connector.

NOTE: Max. 8 PCIe slots are available on the ML350 Gen10.

Storage Controllers

The Gen10 controller naming framework has been updated to simplify identification as depicted below. For a more detailed breakout of the available Gen10 Smart Array controllers visit the [HPE Smart Array Gen10 Controllers Data Sheet](#).

One of the following depending on model

Software RAID HPE Smart Array S100i SR Gen10 SW RAID

NOTE: HPE Smart Array S100i SR Gen10 SW RAID will operate in UEFI mode only. For legacy support an additional controller will be needed, and for CTO orders please also select the Legacy mode settings part, 758959-B22.

NOTE: HPE Smart Array S100i SR Gen10 SW RAID is off by default and must be enabled.

NOTE: The S100i uses 14 embedded SATA ports.

NOTE: The S100i only supports Windows. For Linux users, HPE offers a solution that uses in-distro open-source software to create a two-disk RAID 1 boot volume. For more information visit:

<https://downloads.linux.hpe.com/SDR/project/lrbb/>

Essential RAID Controller HPE Smart Array E208i-a SR Gen10 Controller
 HPE Smart Array E208i-p SR Gen10 Controller
 HPE Smart Array E208e-p SR Gen10 Controller

Performance RAID Controller HPE Smart Array P408i-a SR Gen10 Controller
 HPE Smart Array P408i-p SR Gen10 Controller
 HPE Smart Array P408e-p SR Gen10 Controller
 HPE Smart Array P816i-a SR Gen10 Controller
 HPE Smart Array P824i-p MR Gen10 Controller

NOTE: Performance RAID Controllers require the HPE Smart Storage Battery (P01367-B21) which is sold separately.

NOTE: Separate cable kit will be required depending on configuration requirement. Refer to the later section for more information.

Standard Features

Internal Storage Devices

One of the following depending on model

Optical Drive	Optional slim-line DVD-ROM/DVD-RW up to 1 Optional half-height (5.25") RDX or tape/LTO devices up to 2
Hard Drives	None ship standard

Maximum Internal Storage

	CAPACITY	CONFIGURATION
Hot Plug SFF SAS	48.0 TB	24 x 2 TB
Hot Plug SFF SATA	48.0 TB	24 x 2 TB
Hot Plug LFF SAS	144.0 TB	12 x 12 TB
Hot Plug LFF SATA	144.0 TB	12 x 12 TB
Hot Plug SFF SAS SSD	184.32 TB	24 x 7.68 TB
Hot Plug SFF SATA SSD	92.16 TB	24 x 3.84 TB
Hot Plug LFF SAS SSD	46.08 TB	12 x 3.84 TB
Hot Plug LFF SATA SSD	46.08 TB	12 x 3.84 TB
Non Hot Plug LFF SATA	48.0 TB	12 x 4 TB
Hot Plug SFF NVMe PCIe SSD	32 TB NVMe	8 x 4 TB NVMe

NOTE: NHP LFF SKU supports SATA hard disk drives only.

Power Supply

HPE 500W Standard Non-Hot-Plug Power Supply Kit

NOTE: Non Redunant Power Supply

NOTE: Available in 92% efficiency and supported in pre-configured models only. This power supply is available in a few pre-built system SKUs. Customers can still choose to upgrade to HPE Flex Slot RPS later by installing the ML350 Gen10 RPS enablement kit (874571-B21).

HPE 500W Flex Slot Platinum Hot Plug Low Halogen Power Supply Kit

NOTE: Available in 94% efficiency.

HPE 800W Flex Slot Platinum Hot Plug Low Halogen Power Supply Kit

NOTE: Available in 94% and 96% efficiency.

NOTE: Also available in -48VDC and 227VAC/380VDC power inputs.

HPE 1600W Flex Slot Platinum Hot Plug Low Halogen Power Supply Kit

NOTE: Available in 94% efficiency.

HPE Flexible Slot (Flex Slot) Power Supplies share a common electrical and physical design that allows for hot plug, tool-less installation into HPE ProLiant Gen10 Performance Servers. Flex Slot power supplies are certified for high-efficiency operation and offer multiple output power options, allowing users to "right-size" a power supply for specific server configurations. This flexibility helps to reduce power waste, lower overall energy costs, and avoid "trapped" power capacity in the data center.

All pre-configured servers ship with a country-specific AC power cord in Tower models; while in the Rack model, a standard 6-foot IEC C-13/C-14 jumper cord (416151-B21) is included. If a different power cord is required, please check the [ProLiant Power Cables](#) web page.

To review the power requirements for your selected system, please use the [HPE Power Advisor Tool](#).

For information on power specifications and technical content visit [HPE Server power supplies](#).

Standard Features

Interfaces

Serial	1 standard (at system rear)
VGA Port	1 standard (at system rear)
Display Port	1 standard (at system rear)
Embedded Network Ports	4 x 1 Gb ports shipping standard, with optional stand up card
HPE iLO Remote Management Network Port	1 Gb Dedicated
Front iLO Service Port	1 standard
Micro SD Slot	1 Micro SD (internal)
NOTE: The Micro SD slot is not a hot-pluggable device. Customers should not attempt to plug an SD card into the SD slot while the server is powered.	
USB 3.0/2.0	6 total, standard: 2 front (USB 3.0), 2 rear (USB 3.0), 2 internal (1 x USB 3.0 & 1 x USB 2.0)

Operating Systems and Virtualization Software Support for ProLiant Servers

Windows Server 2012 R2 (Most Recent Version)

Windows Server 2016 (Most Recent Version)

Microsoft Hyper-V Server 2016

VMware vSphere 6.0 U3

VMware vSphere 6.5 and U1

Red Hat Enterprise Linux (RHEL) 6.9, 7.3 and 7.4 (includes KVM)

SUSE Linux Enterprise Server (SLES) 11 SP4, 12 SP2 and 12 SP3 (includes XEN and KVM)

ClearOS

HPE and ClearCenter will help you lower the cost of building on-premise solutions without sacrificing security and ease of use. HPE ProLiant servers with ClearOS give you a simple, secure, and affordable operating system with an intuitive web based graphical user interface that provides a cloud-like experience on-premise, and an Application Marketplace with over 100 apps and growing. Whether you're starting out or scaling, you decide what applications you need and pay as you grow.

NOTE: ClearOS allows you to build a fully functional server that is just right for you at no upfront cost.

For more information on ClearOS, please visit <http://www.hpe.com/servers/clearos>

CentOS

NOTE: CentOS is not directly supported / Community Supported (Based on RHEL so RHEL testing and enablement applicable to CentOS) CentOS 6.9 / CentOS 7.3 / CentOS 7.4.

NOTE: The HPE Software RAID S100i only supports Windows. For Linux users, HPE offers a solution that uses in-distro open-source software to create a two-disk RAID 1 boot volume. For more information visit:

<https://downloads.linux.hpe.com/SDR/project/lsrrb/>

NOTE: For more information on Hewlett Packard Enterprise Certified and Supported ProLiant Servers for OS and Virtualization Software and latest listing of software drivers available for your server.

<http://www.hpe.com/info/ossupport>

Standard Features

Industry Standard Compliance

ACPI 6.1 Compliant

PCIe 3.0 Compliant

WOL Support

Microsoft® Logo certifications

PXE Support

VGA Display Port

USB 3.0 Compliant

USB 2.0 Compliant

Energy Star

SMBIOS 3.1

UEFI 2.6

Redfish API

IPMI 2.0

Secure Digital 2.0

Advanced Encryption Standard (AES)

Triple Data Encryption Standard (3DES)

SNMP v3

TLS 1.2

DMTF Systems Management Architecture for Server Hardware Command Line Protocol (SMASH CLP)

Active Directory v1.0

ASHRAE A3/A4

NOTE: For additional technical thermal details regarding ambient temperatures, humidity and features support please visit: <http://www.hpe.com/servers/ashrae>

UEFI (Unified Extensible Firmware Interface Forum)

NOTE: UEFI is the default setting for the ML350 Gen10. Legacy mode can be selected in the field or as a CTO option (758959-B22).

Graphics

Integrated Video Standard

- Video modes up to 1920 x 1200@60Hz (32 bpp)
- 16MB Video Memory

HPE iLO 5 on system management memory

- 32 MB Flash
- 4 Gbit DDR 3 with ECC protection

HPE Server UEFI/Legacy ROM

Unified Extensible Firmware Interface (UEFI) is an industry standard that provides better manageability and more secured configuration than the legacy ROM while interacting with your server at boot time. HPE ProLiant Gen10 servers have a UEFI Class 2 implementation and support both UEFI Mode (default) and Legacy BIOS Mode.

NOTE: The UEFI System Utilities tool is analogous to the HPE ROM-Based Setup Utility (RBSU) of legacy BIOS. For more information, please visit <http://www.hpe.com/servers/uefi>.

UEFI enables numerous new capabilities specific to HPE ProLiant servers such as:

- Secure Boot and Secure Start enable for enhanced security
- Operating system specific functionality
- Support for > 2.2 TB (using GPT) boot drives
- USB 3.0 Stack
- Embedded UEFI Shell
- Mass Configuration Deployment Tool using iLO RESTful API that is Redfish API Conformant
- PXE boot support for IPv6 networks
- Workload Profiles for simple performance optimization

Standard Features

UEFI Boot Mode only:

- TPM 2.0 Support
- NVMe Boot Support
- Platform Trust Technology (PTT) can be enabled.
- iSCSI Software Initiator Support.
- HTTP/HTTPS Boot support as a PXE alternative.
- Boot support for option cards that only support a UEFI option ROM

NOTE: For UEFI Boot Mode, boot environment and OS image installations should be configured properly to support UEFI.

NOTE: UEFI FIO Setting (758959-B22) can be selected to configure the system in Legacy mode in the factory for your HPE ProLiant Gen10 Server.

Embedded Management

HPE Integrated Lights-Out (HPE iLO)

Monitor your servers for ongoing management, service alerting, reporting and remote management with HPE iLO. Learn more at <http://www.hpe.com/info/ilo>.

UEFI

Configure and boot your servers securely with industry standard Unified Extensible Firmware Interface (UEFI). Learn more at <http://www.hpe.com/servers/uefi>

Intelligent Provisioning

Hassle free server and OS provisioning for 1 or more servers with Intelligent Provisioning. Learn more at <http://www.hpe.com/servers/intelligentprovisioning>

iLO RESTful API

iLO RESTful API is Redfish API conformance and offers simplified server management automation such as configuration and maintenance tasks based on modern industry standards. Learn more at <http://www.hpe.com/info/restfulapi>

Server Utilities

Active Health System

The HPE Active Health System (AHS) is an essential component of the iLO management portfolio that provides continuous, proactive health monitoring of HPE servers. Learn more at <http://www.hpe.com/servers/ahs>

Active Health System Viewer

Use the Active Health System Viewer, a web-based portal, to easily read AHS logs and speed problem resolution with HPE self-repair recommendations, to learn more visit:

<http://www.hpe.com/servers/ahsv>

Smart Update

Keep your servers up to date with the HPE Smart Update solution by using Smart Update Manager (SUM) to optimize the firmware and driver updates of the Service Pack for ProLiant (SPP). Learn more at <http://www.hpe.com/info/smartupdate>.

iLO Amplifier Pack

Designed for large enterprise and service provider environments with hundreds of HPE servers, the iLO Amplifier Pack is a free, downloadable open virtual application (OVA) that delivers the power to discover, inventory and update Gen8, Gen9 and Gen10 HPE servers at unmatched speed and scale. Use with an iLO Advanced License to unlock full capabilities. Learn more at <http://www.hpe.com/servers/iLOamplifierpack>

Standard Features

HPE iLO Mobile Application

Enables the ability to access, deploy, and manage your server anytime from anywhere from select smartphones and mobile devices. For additional information please visit:

<http://www.hpe.com/info/ilo/mobileapp>.

RESTful Interface Tool

RESTful Interface tool (iLOREST) is a single scripting tool to provision using iLO RESTful API to discover and deploy servers at scale. Learn more at <http://www.hpe.com/info/resttool>

Scripting Tools

Provision one to many servers using your own scripts to discover and deploy with Scripting Tool (STK) for Windows and Linux or Scripting Tools for Windows PowerShell. Learn more at <http://www.hpe.com/servers/stk> or

<http://www.hpe.com/servers/powershell>

HPE OneView Standard

HPE OneView Standard can be used for inventory, health monitoring, alerting, and reporting without additional fees. It can monitor multiple HPE server generations. The user interface is similar to the HPE OneView Advanced version, but the software-defined functionality is not available. Learn more at <http://www.hpe.com/info/oneview>.

HPE Systems Insight Manager (HPE SIM)

Ideal for environments already using HPE SIM, it allows you to monitor the health of your HPE ProLiant Servers and HPE Integrity Servers. Also provides you with basic support for non-HPE servers. HPE SIM also integrates with Smart Update Manager to provide quick and seamless firmware updates. Learn more at <http://www.hpe.com/info/hpesim>.

Security

UEFI Secure Boot and Secure Start support

Immutable Silicon Root of Trust

FIPS 140-2 validation (iLO 5 certification in progress)

Common Criteria certification (iLO 5 certification in progress)

Configurable for PCI DSS compliance

Advanced Encryption Standard (AES) and Triple Data Encryption Standard (3DES) on browser

Support for Commercial National Security Algorithms (CNSA)

Tamper-free updates – components digitally signed and verified

Secure Recovery – recover critical firmware to known good state on detection of compromised firmware

Ability to rollback firmware

Secure erase of NAND/User data

TPM (Trusted Platform Module) 1.2 option

TPM (Trusted Platform Module) 2.0 option

Front bezel key-lock feature – standard, available in both Tower and Rack models

Padlock slot, standard

Kensington Lock slot, standard

Standard Features

Warranty

This product is covered by a global limited warranty and supported by HPE Services and a worldwide network of HPE Authorized Channel Partners resellers. Hardware diagnostic support and repair is available for three years from date of purchase. Support for software and initial setup is available for 90 days from date of purchase. Enhancements to warranty services are available through HPE Pointnext operational services or customized service agreements. Hard drives have either a one year or three year warranty; refer to the specific hard drive QuickSpecs for details.

NOTE: Server Warranty includes 3-Year Parts, 3-Year Labor, 3-Year Onsite support with next business day response. Warranty repairs may be accomplished through the use of Customer Self Repair (CSR) parts. These parts fall into two categories: 1) Mandatory CSR parts are designed for easy replacement. A travel and labor charge will result when customers decline to replace a Mandatory CSR part; 2) Optional CSR parts are also designed for easy replacement but may involve added complexity. Customers may choose to have Hewlett Packard Enterprise replace Optional CSR parts at no charge. 3) Non CSR parts must be serviced by a trained authorized service engineer. Additional information regarding worldwide limited warranty and technical support is available at: <http://h17007.www1.hpe.com/us/en/enterprise/servers/warranty/>.

Optional Features

Server Management

HPE iLO Advanced

HPE iLO Advanced licenses offer smart remote functionality without compromise, for all HPE ProLiant servers. The license includes the full integrated remote console, virtual keyboard, video, and mouse (KVM), multi-user collaboration, console record and replay, and GUI-based and scripted virtual media and virtual folders. You can also activate the enhanced security and power management functionality. Learn more about HPE iLO Advanced at

<http://www.hpe.com/servers/iloadvanced>.

HPE iLO Advanced Premium Security Edition

HPE iLO Advanced Premium Security Edition for iLO 5 includes iLO Advanced License plus high-end security modes, unique security capabilities, like Automatic FW recovery; Runtime FW verification, and Secure erase. Learn more about HPE iLO Advanced Premium Security Edition at: <http://www.hpe.com/servers/ilopremium>.

HPE OneView Advanced

HPE OneView brings a new level of automation to infrastructure management by taking a template driven approach to provisioning, updating, and integrating compute, storage, and networking infrastructure. It provides full-featured licenses which can be purchased for managing Gen8, Gen9 and Gen10 servers. To learn more visit

<http://www.hpe.com/info/oneview>.

HPE Insight Cluster Management Utility (CMU)

HPE Insight Cluster Management Utility is a HyperScale management framework that includes software for the centralized provisioning, management and monitoring of nodes and infrastructure. Learn more at <http://www.hpe.com/info/cmu>.

Accelerator and GPGPU Information

Hewlett Packard Enterprise supports various accelerators on select HPE ProLiant servers to support different workloads. The accelerators enable seamless integration of GPU computing with HPE ProLiant servers for high-performance computing, large data center graphics, deep learning and virtual desktop deployments. These accelerators deliver all of the standard benefits of GPU computing while enabling maximum reliability and tight integration with system monitoring and management tools such as HPE Insight Cluster Management Utility.

Optional Features

Rack and Power Infrastructure

The story may end with servers, but it starts with the foundation that makes compute go – and business grow. We've reinvented our entire portfolio of rack and power products to make IT infrastructure more secure, more practical, and more efficient. In other words, we've created a stronger, smarter, and simpler infrastructure to help you get the most out of your IT equipment. As an industry leader, Hewlett Packard Enterprise is uniquely positioned to address the key concerns of power, cooling, cable management and system access.

HPE G2 Advanced and Enterprise Racks are perfect for the server room or today's modern data center with enhanced airflow and thermal management, flexible cable management, and a 10 year Warranty to support higher density computing.

HPE G2 PDUs offer reliable power in flexible form factors that operate at temperatures up to 60°, include color-coded outlets and load segments and a low-profile design for optimal access to the rack and support for dense rack environments.

HPE Uninterruptible Power Systems are cost-effective power protection for any type workload. Some UPSs include options for remote management and extended runtime modules so your critical dense data center is covered in power outages.

HPE KVM Solutions include a console and switches designed to work with your server and IT equipment reliably. We've got a cost-effective KVM switch for your first rack and multiple connection IP switches with remote management and security capabilities to keep your data center rack up and running.

Learn more about HPE Racks, KVM, PDUs and UPSs at [HPE Rack and Power Infrastructure](#).

One Config Simple (SCE)

SCE is a guided self-service tool to help sales and non-technical people provide customers with initial configurations in 3 to 5 minutes. You may then send the configuration on for configuration help, or use in your existing ordering processes. If you require "custom" rack configuration or configuration for products not available in SCE, please contact Hewlett Packard Enterprise Customer Business Center or an Authorized Partner for assistance.

<https://h22174.www2.hpe.com/SimplifiedConfig/Welcome>

Service and Support

HPE Pointnext - Service and Support

Protect your business beyond warranty with HPE Pointnext Operational Service

HPE Pointnext provides a comprehensive portfolio including Advisory and Transformational, Professional, and Operational Services to help accelerate your digital transformation. From the onset of your transformation journey, Advisory and Transformational Services focus on designing the transformation and creating a solution roadmap. Professional Services specializes in creative configurations with flawless and on-time implementation, and on-budget execution. Finally, operational services provides innovative new approaches like Flexible Capacity and Datacenter Care, to keep your business at peak performance. HPE is ready to bring together all the pieces of the puzzle for you, with an eye on the future, and make the complex simple.

Connect your devices:

Unlock all of the benefits of your technology investment by connecting your products to Hewlett Packard Enterprise. Achieve up to 77%¹ reduction in down time, near 100%² diagnostic accuracy and a single consolidated view of your environment. By connecting, you will receive 24x7 monitoring, pre-failure alerts, automatic call logging, and automatic parts dispatch. HPE Proactive Care Service and HPE Datacenter Care Service customers will also benefit from proactive activities to help prevent issues and increase optimization. All of these benefits are already available to you with your server storage and networking products, securely connected to HPE support.

NOTE: 1- IDC 2 – HP CSC reports 2014 – 2015

Learn more about getting connected at <http://www.hpe.com/services/getconnected>.

Recommended Services

HPE Proactive Care* with 6 hour call-to-repair commitment, three year Support Service

HPE Proactive Care gives customers an enhanced call experience. When your products are connected to HPE, Proactive Care helps prevent problems and maintains IT stability by utilizing personalized proactive reports with recommendations and advice. This Service combines three years' proactive reporting and advice with our highest level of hardware support - HPE's 24x7, six hour hardware call-to-repair. HPE is the only leading manufacturer who makes this level of coverage available as a standard service offering for your most valuable servers. This service also includes collaborative software support for Independent Software Vendors (ISVs), (Red Hat, VMWare, Microsoft, etc.) running on your HPE servers.

<https://www.hpe.com/h20195/v2/GetPDF.aspx/4AA3-8855ENW.pdf>

HPE Proactive Care* with 24x7 coverage, three year Support Service

HPE Proactive Care gives customers an enhanced call experience. When your products are connected to HPE, Proactive Care helps prevent problems and maintains IT stability by utilizing personalized proactive reports with recommendations and advice. This Service combines three years proactive reporting and advice with our 24x7 coverage, four hour hardware response time when there is a problem. This service also includes collaborative software support for Independent Software Vendors (ISVs), (Red Hat, VMWare, Microsoft, etc.) running on your HPE servers.

<https://www.hpe.com/h20195/v2/GetPDF.aspx/4AA3-8855ENW.pdf>

HPE Proactive Care* - Next Business Day service, three year Support Service

HPE Proactive Care gives customers an enhanced call experience. When your products are connected to HPE, Proactive Care helps prevent problems and maintains IT stability by utilizing personalized proactive reports with recommendations and advice. This service combines three years of Hardware Support where an HPE authorized representative will arrive at the Customer's site during the onsite coverage window to begin hardware maintenance service the next coverage day after the service request has been logged. This service also includes collaborative software support for Independent Software Vendors (ISVs), (Red Hat, VMWare, Microsoft, etc.) running on your HPE servers.

<https://www.hpe.com/h20195/v2/GetPDF.aspx/4AA3-8855ENW.pdf>

*HPE Proactive Care and HPE Proactive Care Advanced require that the customer connect their devices to make the most of these services and receive all the deliverables.

Service and Support

Service and Support

Parts and Materials

HPE will provide HPE-supported replacement parts and materials necessary to maintain the covered hardware product in operating condition, including parts and materials for available and recommended engineering improvements.

Parts and components that have reached their maximum supported lifetime and/or the maximum usage limitations as set forth in the manufacturer's operating manual, product QuickSpecs, or the technical product data sheet will not be provided, repaired, or replaced as part of these services.

The defective media retention service feature option applies only to Disk or eligible SSD/Flash Drives replaced by HPE due to malfunction.

Other related Services

HPE Server Hardware Installation

Provides for the basic hardware installation of HPE branded servers, storage devices and networking options to assist you in bringing your new hardware into operation in a timely and professional manner.

<https://www.hpe.com/h20195/V2/GetPDF.aspx/5981-9356EN.pdf>

HPE Installation and Startup Service

Provides for the installation of your HPE hardware according to product specifications including options. The HPE service delivery technician will connect the product to a LAN as appropriate and enable remote support to allow for automatic case creation for hardware failures. Installation and start up services also includes the installation of one supported operating system type (Windows® or Linux).

HPE Datacenter Care service

HPE Datacenter Care helps improve IT stability and security, increase the value of IT, and enable agility and innovation. It is a structured framework of repeatable, tested, and globally available services “building blocks.” You can deploy, operate, and evolve your datacenter wherever you are on your IT journey. With HPE Datacenter Care, you benefit from a personalized relationship with HPE via a single point of accountability for HPE and others' products. For more information, visit

<http://www.hpe.com/services/datacentercare>

HPE GreenLake Flex Capacity

With HPE GreenLake Flex Capacity, you get the speed, scalability, and economics of the public cloud in the privacy of your data center. Gain the advantages of the public cloud—consumption-based payment, rapid scalability without worrying about capacity constraints. Reduce the “heavy lifting” needed to operate a data center. And retain the advantages that IT provides the business (i.e., control, security). Deliver the right user experience, choose the right technology for the business, manage privacy and compliance, and manage the cost of IT. And, you have the option to use the public cloud when needed.

DC for Hyperscale

Datacenter Care for Hyperscale is available for Service Providers and HPC customers who use a scale out approach to computing with a high volume homogenous infrastructure and resilient architecture can take advantage of this environment support tailored to their operating model.

HPE Factory Express for Servers and storage

HPE Factory Express offers configuration, customization, integration and deployment services for HPE servers and storage products. Customers can choose how their factory solutions are built, tested, integrated, shipped and deployed.

Factory Express offers service packages for simple configuration, racking, installation, complex configuration and design services as well as individual factory services, such as image loading, asset tagging, and custom packaging. HPE products supported through Factory Express include a wide array of servers and storage: HPE Integrity, HPE ProLiant, HPE Apollo, HPE ProLiant Server Blades, HPE BladeSystem, HPE 9000 servers as well as the MSAXXX3PAR suite, XP, rackable tape libraries and configurable network switches.

Service and Support

HPE Service Credits

HPE Service Credits offers flexible services and technical skills to meet your changing IT demands. With a menu of service that is tailored to suit your needs, you get additional resources and specialist skills to help you maintain peak performance of your IT. Offered as annual credits, you can plan your budgets while proactively responding to your dynamic business.

HPE Education Services

Keep your IT staff trained making sure they have the right skills to deliver on your business outcomes. Book on a class today and learn how to get the most from your technology investment.

<http://www.hpe.com/ww/learn>

HPE Support Center

The HPE Support Center is a personalized online support portal with access to information, tools and experts to support HPE business products. Submit support cases online, chat with HPE experts, access support resources or collaborate with peers.

Learn more <http://www.hpe.com/support/hpesc>.

HPE's Support Center Mobile App* allows you to resolve issues yourself or quickly connect to an agent for live support. Now, you can get access to personalized IT support anywhere, anytime.

HPE Insight Remote Support and HPE Support Center are available at no additional cost with a HPE warranty, HPE Support Service or HPE contractual support agreement.

*HPE Support Center Mobile App is subject to local availability.

For more information: <http://www.hpe.com/services>.

NOTE: HPE ProLiant ML350 Gen10 Server is covered under the HPE Service Contract applied to the HPE ProLiant Server. No separate HPE support services need to be purchased.

Warranty and Support Services will extend to include HPE options configured with your server or storage device. The price of support service is not impacted by configuration details. HPE sourced options that are compatible with your product will be covered under your server support at the same level of coverage allowing you to upgrade freely. Installation for HPE options is available as needed. To keep support costs low for everyone, some high value options will require additional support. Additional support is only required on select high value workload accelerators, fibre switches, InfiniBand and UPS batteries over 12KVA. See the specific high value options that require additional support [HERE](#).

Pre-configured Models

For the Standard Features shipped in the "Factory Integrated Models", please see the "Configuration Information - Factory Integrated Models" section.

1. Pre-configured models ship with the configurations below. Options can be selected from the Core or Additional options section of this QuickSpecs.
2. Hewlett Packard Enterprise does not allow factory integration of options into pre-configured models. Any additional options purchased will be shipped separately.
3. If you desire a custom configuration please see "Configuration Information - Factory Integrated Models" section of this QuickSpecs

	Sub-Entry Model	Entry Model	Base Model
[SKU Number]	877619-xx1	877620-xx1	877621-xx1
Localization	US, UK, EU, AP, Japan & China	US, UK, EU, AP, Japan & China	US, UK, EU, AP/Japan & China
Model Name	HPE ML350 Gen10 3104 1P 8G 4LFF NHP S100i 500W PS Sub-Entry Tower Server	HPE ML350 Gen10 3106 1P 16G 4LFF S100i 500W FS RPS Entry Tower Server	HPE ML350 Gen10 4110 1P 16G 8SFF P408i-a 800W FS RPS Base Tower Server
Processor	3104 (6-Core, 1.7 GHz, 85W)	3106 (8-Core, 1.7 GHz, 85W)	4110 (8-Core, 2.1 GHz, 85W)
Number of Processors	One processor		
Memory	8 GB RDIMM SR 2600 MT/s (1x 8 GB) NOTE: running at 2133 MT/s due to Processor limitation.	16 GB RDIMM SR 2600 MT/s (1x 16 GB) NOTE: running at 2133 MT/s due to Processor limitation.	16 GB RDIMM SR 2600 MT/s (1x 16 GB) NOTE: running at 2400 MT/s due to Processor limitation.
Network Controller	Embedded 4-Port 1GbE HPE Ethernet 1Gb 4-port 369i Adapter NOTE: embedded 4x1GbE HPE Ethernet 1Gb 4-port 369i Adapter does not support speeds of 100MB/s and 10MB/s.		
Storage Controller	Embedded 14-Port S100i NOTE: SATA only. NOTE: NOT field upgradeable to SAS or hardware RAID capability.	Embedded 14-Port S100i NOTE: SATA only. NOTE: Field upgradeable to SAS by selecting HPE modular Smart Array controller.	P408i-a NOTE: 8-Port modular Smart Array. NOTE: Smart Storage battery included.
Hard Drive	None ship as standard		
Internal Storage	4 LFF NHP chassis with optional HDD Cage Kit (874567-B21) to be selected. Upgradeable to 12 LFF max.	4 LFF HP Chassis with optional HDD Cage Kit (874566-B21) to be selected. Upgradeable to 12 LFF max. NOTE: The HPE ML350 Gen10 LFF Embedded SATA Cable Kit (877578-B21) is required when upgrading to add the 2nd or 3rd HDD cage kit, using S100i controller. One cable kit per cage.	8 SFF chassis with optional SFF HDD Cage Kit (874568-B21) to be selected. Upgradeable to 24 SFF max. Opt. 8 SFF NVMe Express Bay Kit (874569-B21)
Optical Drive Bay	Optional Slimline ODD Bay Kit (874577-B21) for SATA DVD-ROM/DVD-RW optical drive Optional Media Drive Support Kit (874570-B21) for RDX or tape/LTO devices, up to 2		
Optical Drive	None ship as standard		
PCI-Express Slots	4-slots (x16, x8, x16, x8) as standard NOTE: PCIe slots 5 – 8 require the second optional processor.		
Power Supply	1x 500W HPE Standard Non-Hot-Plug/non-RPS Power Supply	1x 500W HPE FlexSlot Power Supply NOTE: Add a second 500W FlexSlot power supply to get 1+1 power redundancy feature.	1x 800W HPE FlexSlot Power Supply NOTE: Add a second 800W FlexSlot power supply to get 1+1 power redundancy feature.

Pre-configured Models

Fans	2 standard fans; Optional redundant fan cage kit (874572-B21, add'l 4 fans)	
Management	HPE iLO Standard with Intelligent Provisioning (embedded), HPE OneView Standard (requires download); HPE iLO Advanced, HPE iLO Advanced Premium Security Edition, and HPE OneView Advanced (require licenses)	
Energy Star	2.1 certified	
Form Factor	4U Tower NOTE: Optional Tower-to-Rack conversion kit (874578-B21) to convert the unit to a 5U Rack-mount server.	
Warranty	3-year parts, 3-year labor, 3-year onsite support with next business day response.	
	Performance Model – Rack	Performance Model
[SKU Number]	877622-xx1	877623-xx1
Localization	US, UK, EU & AP	US, UK, EU & AP
Model Name	HPE ML350 Gen10 4114 2P 32G 8SFF P408i-a 2x800W FS RPS Performance Rack Server	HPE ML350 Gen10 5118 2P 32G 8SFF P408i-a 2x800W FS RPS Performance Tower Server
Processor	4114 (10-Core, 2.2 GHz, 85W)	5118 (12-Core, 2.3 GHz, 105W)
Number of Processors	Two processors	
Memory	32 GB RDIMM SR 2600 MT/s (2x 16 GB) NOTE: running at 2400 MT/s due to Processor limitation.	
Network Controller	Embedded 4-Port 1GbE HPE Ethernet 1Gb 4-port 369i Adapter NOTE: embedded 4x1GbE HPE Ethernet 1Gb 4-port 369i Adapter does not support speeds of 100MB/s and 10MB/s.	
Storage Controller	P408i-a NOTE: 8-Port modular Smart Array. NOTE: Smart Storage battery included.	
Hard Drive	None ship as standard	
Internal Storage	8 SFF chassis with optional SFF HDD Cage Kit (874568-B21), upgradeable to 24 SFF. Opt. 8 SFF NVMe Express Bay Kit (874569-B21)	
Optical Drive Bay	Optional Slimline ODD Bay Kit (874577-B21) for SATA DVD-ROM/DVD-RW optical drive Optional Media Drive Support Kit (874570-B21) for RDX or tape/LTO devices, up to 2	
Optical Drive	None ship as standard	
PCI-Express Slots	8-slots (x16, x8, x16, x8, x16, x8, x16, x8) as standard	
Power Supply	2x 800W HPE FlexSlot power supply (1+1)	
Fans	6 standard fans	
Management	HPE iLO Standard with Intelligent Provisioning (embedded), HPE OneView Standard (requires download); HPE iLO Advanced, HPE iLO Advanced Premium Security Edition, and HPE OneView Advanced (require licenses)	
Energy Star	2.1 certified	
Form Factor	5U Rack	4U Tower
Warranty	3-year parts, 3-year labor, 3-year onsite support with next business day response	

Pre-configured Models

	Solution Model
[SKU Number]	P04674-xxx
Localization	US, EU/UK, AP & JP
Model Name	HPE ML350 Gen10 4110 1P 16G 8SFF E208i-a 800W FS RPS Solution Tower Server
Processor	4110 (8-Core, 2.1 GHz, 85W)
Number of Processors	One processor
Memory	16 GB RDIMM SR 2600 MT/s (1x 16 GB) NOTE: running at 2400 MT/s due to Processor limitation.
Network Controller	Embedded 4-Port 1GbE HPE Ethernet 1Gb 4-port 369i Adapter NOTE: embedded 4x1GbE HPE Ethernet 1Gb 4-port 369i Adapter does not support speeds of 100MB/s and 10MB/s.
Storage Controller	E208i-a NOTE: 8-Port modular Smart Array with essential RAID/no Cache. NOTE: Smart Storage battery NOT included.
Hard Drive	None ship as standard
Internal Storage	8 SFF chassis with optional SFF HDD Cage Kit (874568-B21) to be selected. Upgradeable to 24 SFF max. Opt. 8 SFF NVMe Express Bay Kit (874569-B21)
Optical Drive Bay	Optional Slimline ODD Bay Kit (874577-B21) for SATA DVD-ROM/DVD-RW optical drive Optional Media Drive Support Kit (874570-B21) for RDX or tape/LTO devices, up to 2
Optical Drive	None ship as standard
PCI-Express Slots	4-slots (x16, x8, x16, x8) as standard NOTE: PCIe slots 5 – 8 require the second optional processor.
Power Supply	1x 800W HPE FlexSlot Power Supply NOTE: Add a second 800W FlexSlot power supply to get 1+1 power redundancy feature.
Fans	2 standard fans; Optional redundant fan cage kit (874572-B21, add'l 4 fans)
Software	ClearOS/ClearVM NOTE: ClearOS/VM installer on a 8GB USB flash key pre-built inside the system.
Management	HPE iLO Standard with Intelligent Provisioning (embedded), HPE OneView Standard (requires download); HPE iLO Advanced, HPE iLO Advanced Premium Security Edition, and HPE OneView Advanced (require licenses)
Energy Star	2.1 certified
Form Factor	4U Tower NOTE: Optional Tower-to-Rack conversion kit (874578-B21) to convert the unit to a 5U Rack-mount server.
Warranty	3-year parts, 3-year labor, 3-year onsite support with next business day response.

Country Code Key	xx1 = 001	US
	xx1 = 031	UK
	xx1 = 421	EU
	xx1 = 371	AP
	xx1 = 291	Japan
	xx1 = AA1	PRC
	xx1 = B21	Worldwide

NOTE: Not all models are available in all regions. Check with your local country Hewlett Packard Enterprise offices for availability.

Configuration Information - Factory Integrated Models

This section lists some of the steps required to configure a Factory Integrated Model. To ensure only valid configurations are ordered, Hewlett Packard Enterprise recommends the use of an HPE approved configurator. Contact your local sales representative for information on configurable product offerings and requirements.

1. Factory Integrated Models must start with a CTO Server.
2. FIO indicates that this option is only available as a factory installable option.
3. All Factory Integrated Models will be populated with sufficient hard drive blanks based on the number of initial hard drives ordered with the server.
4. Some options may not be integrated at the factory. Contact your local sales representative for additional information.

Step 1: Base Configuration (choose one of the following configurable models)

CTO Server	HPE ML350 Gen10 4 LFF CTO Server	HPE ML350 Gen10 8 SFF CTO Server	HPE ML350 Gen10 8 SFF Rack CTO Server
SKU Number	877625-B21	877626-B21	877627-B21
Processor Sockets	Two as standard	Two as standard	Two as standard
Processor	Not included as standard	Not included as standard	Not included as standard
DIMM Slots	24-DIMM slots	24-DIMM slots	24-DIMM slots
Storage Controller	Embedded SW RAID S100i with 14 SATA ports, choice of HPE modular Smart Array (AROC) and/or PCIe Standup controller card (s)		
PCIe	8 PCIe Gen3 slots (x16, x8, x16, x8, x16, x8, x16, x8) as standard		
Drive Cage - included	4 LFF	8 SFF	8 SFF
Network Controller	Embedded 4x1GbE HPE Ethernet 1Gb 4-port 369i Adapter with optional 1/10/25Gb Standup card NOTE: embedded 4x1GbE HPE Ethernet 1Gb 4-port 369i Adapter does not support speeds of 100MB/s and 10MB/s.		
Fans	2-Standard	2-Standard	6-Standard
Power Supply Cage included	HPE Flex Slot RPS cage and PDB included	HPE Flex Slot RPS cage and PDB included	HPE Flex Slot RPS cage and PDB included
Management	HPE iLO with Intelligent Provisioning (standard), iLO Advances and OneView (optional)		
USB	6x 3.0/2.0 standard plus front iLO Service Port	6x 3.0/2.0 standard plus front iLO Service Port	6x 3.0/2.0 standard plus front iLO Service Port
Tower-to-Rack conversion kit	Optional	Optional	Easy Install rack-rail tray (1U) with CMA included as mandatory (must-select) accessories

NOTE: Refer to HPE Power Advisor Tool to review the power requirement for your selected configuration and determine what power supply module(s) to select.

Additional drive cages	Optional 4xLFF HDD Cage kit, up to 2 (total of 3)	Optional 8xSFF HDD Cage kit, up to 2 (total of 3)	Optional 8xSFF HDD Cage kit, up to 2 (total of 3)
Half-Height Media Bay	2 Optional	2 Optional	2 Optional
ODD	1 Optional	1 Optional	1 Optional
Redundant Fan Cage Kit	Optional	Optional	Included as standard – total 6 fans included
8 SFF NVMe Express Bay	Not available	Optional, up to 1	Optional, up to 1

Configuration Information - Factory Integrated Models

NOTE: This applies to CTO configurations, field upgrades may differ depending on field configuration.

NOTE: The HH Media Bay (2) and slim ODD Bay together takes up the space of one 4 LFF or 8 SFF drive cage, which means when media bay, ODD or both is selected, the max. drive cage installation will be 2.

NOTE: To get advanced cooling in richer configurations and/or under certain ambient environmental conditions, the Redundant Fan Cage Kit (874572-B21) which consists of one fan cage with 4 additional fans, is REQUIRED. This kit is automatically selected when the Rack CTO SKU is selected. Refer to the Redundant Fan Kit section or ML350 Gen10 User Guide for detail.

NOTE: When the 8SFF Rack CTO Server (877627-B21) is selected, the Redundant Fan Cage Kit (874572-B21) and ML350 Gen10 T/R Conversion Kit (874578-B21) will be automatically selected.

Step 2a: Choose Required Options - Processors (only one of the following unless otherwise noted)

Please select one –L21 processor required below.

For second processor, please select the same processor model with –B21 from Core Options – HPE Processors section.

For example: first processor, select 874752-L21 then for second processor, select 874752-B21.

NOTE: 1P models typically ship with 2 standard fans. 2P models will require selection of the Redundant Fan Cage kit (874572-B21) which contains one fan cage along with 4 additional fans – total number of fans required in the system will be 6.

NOTE: Maximum memory capacity per processor is dependent on processor models. All processors support up to 768 GB max memory per processor except “M” model processors will support up to 1.5 TB max memory per processor.

NOTE: Mixing of 2 different processor models are NOT allowed.

NOTE: DDR4 speed is the maximum memory speed of the processor. Actual memory speed may depend on the quantity and type of DIMMs installed.

NOTE: Processors higher than 85W will ship with the Performance heat sink. All other processors will ship with the Standard heat sink.

Processor Option Kits

Required Processor

HPE ML350 Gen10 Intel Xeon-Platinum 8180M (2.5GHz/28-core/205W) FIO Processor Kit

878663-L21

NOTE: Ships with Performance Heatsink.

HPE ML350 Gen10 Intel Xeon-Platinum 8180 (2.5GHz/28-core/205W) FIO Processor Kit

878662-L21

NOTE: Ships with Performance Heatsink.

HPE ML350 Gen10 Intel Xeon-Platinum 8176M (2.1GHz/28-core/165W) FIO Processor Kit

878666-L21

NOTE: Ships with Performance Heatsink.

HPE ML350 Gen10 Intel Xeon-Platinum 8176 (2.1GHz/28-core/165W) FIO Processor Kit

878661-L21

NOTE: Ships with Performance Heatsink.

HPE ML350 Gen10 Intel Xeon-Platinum 8170M (2.1GHz/26-core/165W) FIO Processor Kit

878660-L21

NOTE: Ships with Performance Heatsink.

HPE ML350 Gen10 Intel Xeon-Platinum 8170 (2.1GHz/26-core/165W) FIO Processor Kit

878659-L21

NOTE: Ships with Performance Heatsink.

HPE ML350 Gen10 Intel Xeon-Platinum 8168 (2.7GHz/24-core/205W) FIO Processor Kit

878665-L21

NOTE: Ships with Performance Heatsink.

HPE ML350 Gen10 Intel Xeon-Platinum 8164 (2.0GHz/26-core/150W) FIO Processor Kit

878658-L21

NOTE: Ships with Performance Heatsink.

HPE ML350 Gen10 Intel Xeon-Platinum 8160M (2.1GHz/24-core/150W) FIO Processor Kit

878664-L21

NOTE: Ships with Performance Heatsink.

HPE ML350 Gen10 Intel Xeon-Platinum 8160 (2.1GHz/24-core/150W) FIO Processor Kit

878657-L21

NOTE: Ships with Performance Heatsink.

HPE ML350 Gen10 Intel Xeon-Platinum 8158 (3.0GHz/12-core/150W) FIO Processor Kit

878656-L21

NOTE: Ships with Performance Heatsink.

Configuration Information - Factory Integrated Models

HPE ML350 Gen10 Intel Xeon-Platinum 8156 (3.6GHz/4-core/105W) FIO Processor Kit	878655-L21
NOTE: Ships with Performance Heatsink.	
HPE ML350 Gen10 Intel Xeon-Platinum 8153 (2.0GHz/16-core/125W) FIO Processor Kit	878654-L21
HPE ML350 Gen10 Intel Xeon-Gold 6150 (2.7GHz/18-core/165W) FIO Processor Kit	878651-L21
NOTE: Ships with Performance Heatsink.	
HPE ML350 Gen10 Intel Xeon-Gold 6154 (3.0GHz/18-core/200W) FIO Processor Kit	878653-L21
NOTE: Ships with Performance Heatsink.	
HPE ML350 Gen10 Intel Xeon-Gold 6152 (2.1GHz/22-core/140W) FIO Processor Kit	878652-L21
NOTE: Ships with Performance Heatsink.	
HPE ML350 Gen10 Intel Xeon-Gold 6148 (2.4GHz/20-core/150W) FIO Processor Kit	878650-L21
NOTE: Ships with Performance Heatsink.	
HPE ML350 Gen10 Intel Xeon-Gold 6146 (xxxGHz/12-core/165W) FIO Processor Kit	878649-L21
NOTE: Ships with Performance Heatsink.	
HPE ML350 Gen10 Intel Xeon-Gold 6144 (xxxGHz/8-core/155W) FIO Processor Kit	878648-L21
NOTE: Ships with Performance Heatsink.	
HPE ML350 Gen10 Intel Xeon-Gold 6142M (2.6GHz/16-core/150W) FIO Processor Kit	878647-L21
NOTE: Ships with Performance Heatsink.	
HPE ML350 Gen10 Intel Xeon-Gold 6142 (2.6GHz/16-core/150W) FIO Processor Kit	866558-L21
NOTE: Ships with Performance Heatsink.	
HPE ML350 Gen10 Intel Xeon-Gold 6140M (2.3GHz/18-core/140W) FIO Processor Kit	866556-L21
NOTE: Ships with Performance Heatsink.	
HPE ML350 Gen10 Intel Xeon-Gold 6140 (2.3GHz/18-core/140W) FIO Processor Kit	866554-L21
NOTE: Ships with Performance Heatsink.	
HPE ML350 Gen10 Intel Xeon-Gold 6138 (2.0GHz/20-core/125W) FIO Processor Kit	866552-L21
NOTE: Ships with Performance Heatsink.	
HPE ML350 Gen10 Intel Xeon-Gold 6136 (3.0GHz/12-core/150W) FIO Processor Kit	866550-L21
NOTE: Ships with Performance Heatsink.	
HPE ML350 Gen10 Intel Xeon-Gold 6134M (3.2GHz/8-core/130W) FIO Processor Kit	880215-L21
NOTE: Ships with Performance Heatsink.	
HPE ML350 Gen10 Intel Xeon-Gold 6134 (3.2GHz/8-core/130W) FIO Processor Kit	880214-L21
NOTE: Ships with Performance Heatsink.	
HPE ML350 Gen10 Intel Xeon-Gold 6132 (2.6GHz/14-core/140W) FIO Processor Kit	866548-L21
NOTE: Ships with Performance Heatsink.	
HPE ML350 Gen10 Intel Xeon-Gold 6130 (2.1GHz/16-core/125W) FIO Processor Kit	866546-L21
HPE ML350 Gen10 Intel Xeon-Gold 6128 (3.4GHz/6-core/115W) FIO Processor Kit	866544-L21
NOTE: Ships with Performance Heatsink.	
HPE ML350 Gen10 Intel Xeon-Gold 6126 (2.6GHz/12-core/125W) FIO Processor Kit	866542-L21
HPE ML350 Gen10 Intel Xeon-Gold 5122 (3.6GHz/4-core/105W) FIO Processor Kit	866540-L21
NOTE: Ships with Performance Heatsink.	
HPE ML350 Gen10 Intel Xeon-Gold 5120 (2.2GHz/14-core/105W) FIO Processor Kit	866538-L21
NOTE: Ships with Performance Heatsink.	
HPE ML350 Gen10 Intel Xeon-Gold 5118 (2.3GHz/12-core/105W) FIO Processor Kit	866536-L21
NOTE: Ships with Performance Heatsink.	
HPE ML350 Gen10 Intel Xeon-Gold 5115 (2.4GHz/10-core/85W) FIO Processor Kit	866534-L21

Configuration Information - Factory Integrated Models

HPE ML350 Gen10 Intel Xeon-Silver 4116 (2.1GHz/12-core/85W) FIO Processor Kit	866532-L21
HPE ML350 Gen10 Intel Xeon-Silver 4114 (2.2GHz/10-core/85W) FIO Processor Kit	866530-L21
HPE ML350 Gen10 Intel Xeon-Silver 4112 (2.6GHz/4-core/85W) FIO Processor Kit	866528-L21
HPE ML350 Gen10 Intel Xeon-Silver 4110 (2.1GHz/8-core/85W) FIO Processor Kit	866526-L21
HPE ML350 Gen10 Intel Xeon-Silver 4108 (1.8GHz/8-core/85W) FIO Processor Kit	866524-L21
HPE ML350 Gen10 Intel Xeon-Bronze 3106 (1.7GHz/8-core/85W) FIO Processor Kit	866522-L21
HPE ML350 Gen10 Intel Xeon-Bronze 3104 (1.7GHz/6-core/85W) FIO Processor Kit	866520-L21

NOTE: Processors above 85W use a Performance Heatsink.

Step 2b: Choose Memory Options

Please select one or more memory from below.

For new Gen10 memory population rule whitepaper and optimal memory performance guidelines, please go to:

<https://www.hpe.com/docs/memory-population-rules>

For Gen10 memory speed table, please go to: <https://www.hpe.com/docs/memory-speed-table>

For memory Reliability, Accessibility, Serviceability (RAS) features whitepaper like Gen10 Fast Fault Tolerance and legacy mirrored memory feature etc. please go to: <http://www.hpe.com/docs/memory-ras-feature>

NOTE: Memory DIMM availability with a server platform is dependent upon completion of certification testing.

NOTE: The maximum memory speed is a function of the memory type, memory configuration, and processor model.

Memory

HPE 8GB (1x8GB) Single Rank x8 DDR4-2666 CAS-19-19-19 Registered Smart Memory Kit	815097-B21
HPE 16GB (1x16GB) Single Rank x4 DDR4-2666 CAS-19-19-19 Registered Smart Memory Kit	815098-B21
HPE 16GB (1x16GB) Dual Rank x8 DDR4-2666 CAS-19-19-19 Registered Smart Memory Kit	835955-B21
HPE 32GB (1x32GB) Dual Rank x4 DDR4-2666 CAS-19-19-19 Registered Smart Memory Kit	815100-B21
HPE 64GB (1x64GB) Quad Rank x4 DDR4-2666 CAS-19-19-19 Load Reduced Smart Memory Kit	815101-B21
HPE 128GB (1x128GB) Octal Rank x4 DDR4-2666 CAS-22-19-19 3DS Load Reduced Memory Kit	815102-B21

Step 2c: Choose Power Supplies

NOTE: Mixing of 2 different power supplies is NOT allowed.

NOTE: Selection of two HPE Flex Slot power supplies provides 1+1 power redundancy.

NOTE: To review the power requirements for your selected configuration, please use the [HPE Power Advisor Tool](#).

Power Supplies

HPE 500W Flex Slot Platinum Hot Plug Low Halogen Power Supply Kit	865408-B21
HPE 800W Flex Slot Titanium Hot Plug Low Halogen Power Supply Kit	865438-B21
HPE 800W Flex Slot Platinum Hot Plug Low Halogen Power Supply Kit	865414-B21
HPE 800W Flex Slot -48VDC Hot Plug Low Halogen Power Supply Kit	865434-B21
HPE 800W Flex Slot Universal Hot Plug Low Halogen Power Supply Kit	865428-B21
HPE 1600W Flex Slot Platinum Hot Plug Low Halogen Power Supply Kit	830272-B21

Step 3: Choose Additional Factory Integratable Options

One of the following from each list may be selected if desired at time of factory integration.

HPE Unique Options

HPE ML350 Gen10 8SFF Hot Plug Drive Backplane Cage Kit	874568-B21
--	------------

NOTE: Add additional 8 SFF hot-plug hard drive cage, allowing for up to 24 SFF drive support (8+8+8).

HPE ML350 Gen10 4LFF Hot Plug Drive Backplane Cage Kit	874566-B21
--	------------

Configuration Information - Factory Integrated Models

NOTE: Add additional 4 LFF hot-plug hard drive cage, allowing for up to 12 LFF drive support (4+4+4).

HPE ML350 Gen10 8SFF NVMe SSD Express Bay Enablement Kit with 2x4NVMe Risers and Support Cables 874569-B21

NOTE: This kit contains two x4 Direct Attach PCIe NVMe Riser Boards with each supporting up to 4 drives. When both Riser Boards are installed, the system supports up to 8 SFF NVMe drives.

NOTE: NVMe SSDs to be ordered separately.

NOTE: NVMe drives require the addition of HPE ML350 Gen10 Redundant Fan Cage Kit (874572-B21).

HPE ML350 Gen10 RDX/LTO Media Drive Support Cable Kit with Fan Blank for Long LTO 874570-B21

NOTE: Supporting cables to add additional RDX/tape devices for data backup or archiving.

NOTE: RDX/tape devices to be ordered separately

NOTE: In the case when LTO Internal Tape is selected along with the Fan Redundant Kit, Fan#1 will need to be removed and the Fan Blank provided in this option kit will need to be installed in Fan#1 location. This configuration will run without fan redundancy.

Refer to **ML350 Gen10 User Guide** for more detail.

HPE ML350 Gen10 Slimline ODD Bay and Support Cable Kit 874577-B21

NOTE: Mechanical converter with supporting cable.

HPE Factory Configuration Setting

HPE Legacy FIO Mode Setting 758959-B22

NOTE: UEFI is the default, this FIO part can be used for CTO to enable Legacy mode.

HPE Smart Memory Fast Fault Tolerance FIO Setting 875293-B21

HPE Converged Infrastructure Management Software

HPE OneView for ProLiant DL Server including 3yr 24x7 Support FIO Bundle Physical 1-server LTU E5Y43A

HPE OneView w/o iLO including 3yr 24x7 Support 1-server FIO LTU P8B31A

Step 4: Choose additional options for Factory Integration from Core and Additional Options sections below

Core Options

NOTE: Some options may not be integrated at the factory. To ensure only valid configurations are ordered, Hewlett Packard Enterprise recommends the use of an HPE approved configurator. Contact your local sales representative for additional information. Note the [User Guide \(UG\)](#) can help to explain the cable routing for each option.

HPE Unique Options

HPE ML350 Gen10 8SFF Hot Plug Drive Backplane Cage Kit 874568-B21

NOTE: Add additional 8 SFF Hot-Plug Hard Drive Cage, allowing for up to 24 SFF Drive support (8+8+8).

HPE ML350 Gen10 4LFF Hot Plug Drive Backplane Cage Kit 874566-B21

NOTE: Add additional 4 LFF Hot-Plug Hard Drive Cage, allowing for up to 12 LFF Drive support (4+4+4).

HPE ML350 Gen10 4LFF Non Hot Plug Drive Cage Kit 874567-B21

NOTE: Field upgrade only. NHP drive cage is for NHP server only. Add additional 4 LFF Non-Hot-Plug Hard Drive Cage, allowing for up to 12 LFF NHP Drive support (4+4+4).

HPE ML350 Gen10 8SFF NVMe SSD Express Bay Enablement Kit with 2x4NVMe Risers and Support Cables 874569-B21

NOTE: This kit contains two x4 Direct Attach PCIe NVMe Riser Boards with each supporting up to 4 drives. When both Risers are installed, it supports 8 SFF NVMe drives.

NOTE: SFF NVMe SSDs to be ordered separately.

NOTE: NVMe drives require the addition of HPE ML350 Gen10 Redundant Fan Cage Kit (874572-B21).

HPE ML350 Gen10 Embedded SATA Cable Kit for LFF Configuration 877578-B21

NOTE: This cable kit is used to support the embedded SATA controller with S100i SW RAID. One cable kit per HDD cage.

HPE ML350 Gen10 Embedded SATA Cable Kit for SFF Configuration 877579-B21

NOTE: This cable kit is used to support the embedded SATA controller with S100i SW RAID. One cable kit per HDD cage.

HPE ML350 Gen10 AROC Mini-SAS Cable Kit for LFF Configuration 874573-B21

HPE ML350 Gen10 AROC Mini-SAS Cable Kit for SFF Configuration 877575-B21

HPE ML350 Gen10 Smart Array/HBA Mini-SAS Cable Kit for LFF Configuration 874574-B21

HPE ML350 Gen10 Smart Array/HBA Mini-SAS Cable Kit for SFF Configuration 874575-B21

HPE ML350 Gen10 12Gb SAS Expander Card Kit with Cables 874576-B21

HPE ML350 Gen10 Redundant Fan Cage Kit with 4 Fan Modules 874572-B21

NOTE: Add additional 4 hot-plug fans installed in the fan cage to get N+1 fan redundancy and/or for advanced cooling. Refer to later section for detail.

HPE ML350 Gen10 Flex Slot Redundant Power Supply Cage Kit with Power Distribution Board 874571-B21

NOTE: Field upgrade only. Allowing field upgrade from the 500W standard PSU/non-hot-plug/non-RPS to support HPE Flex Slot RPS.

HPE ML350 Gen10 GPU External Power Cable Kit 877628-B21

NOTE: Consists of two external power cables to feed power to GPU modules with TDP larger than 75W – that is, this GPU external power cable kit is required except for HPE NVIDIA Quadro P2000 GPU module. The longer GPU power cable is intended to support GPU installation in PCIe slot 1 or 3 (slots coming from CPU 1); while the other shorter cable to support slot 5 or 7 (slots coming from CPU 2).

HPE ML Gen10 Tower to Rack Conversion Kit with Sliding Rail Rack Shelf and Cable Management Arm 874578-B21

NOTE: This kit is supported in both ML350 and ML110 Gen10.

HPE ML350 Gen10 RDX/LTO Media Drive Support Cable Kit with Fan Blank for Long LTO 874570-B21

NOTE: Supporting cables to add additional RDX/tape devices for data backup or archiving.

NOTE: RDX/tape devices to be ordered separately.

Core Options

NOTE: In the case when LTO Internal Tape is selected along with the Fan Redundant Kit, Fan#1 will need to be removed and the Fan Blank provided in this option kit will need to be installed in Fan#1 location. This configuration will run without fan redundancy. Refer to [ML350 Gen10 User Guide](#) for more detail.

HPE ML350 Gen10 Slimline ODD Bay and Support Cable Kit 874577-B21

NOTE: Mechanical converter with supporting cable.

HPE Processors

Processor Option Kits

HPE ML350 Gen10 Intel Xeon-Platinum 8180M (2.5GHz/28-core/205W) Processor Kit 878663-B21

NOTE: Ships with Performance Heatsink.

HPE ML350 Gen10 Intel Xeon-Platinum 8180 (2.5GHz/28-core/205W) Processor Kit 878662-B21

NOTE: Ships with Performance Heatsink.

HPE ML350 Gen10 Intel Xeon-Platinum 8176M (2.1GHz/28-core/165W) Processor Kit 878666-B21

NOTE: Ships with Performance Heatsink.

HPE ML350 Gen10 Intel Xeon-Platinum 8176 (2.1GHz/28-core/165W) Processor Kit 878661-B21

NOTE: Ships with Performance Heatsink.

HPE ML350 Gen10 Intel Xeon-Platinum 8170M (2.1GHz/26-core/165W) Processor Kit 878660-B21

NOTE: Ships with Performance Heatsink.

HPE ML350 Gen10 Intel Xeon-Platinum 8170 (2.1GHz/26-core/165W) Processor Kit 878659-B21

NOTE: Ships with Performance Heatsink.

HPE ML350 Gen10 Intel Xeon-Platinum 8168 (2.7GHz/24-core/205W) Processor Kit 878665-B21

NOTE: Ships with Performance Heatsink.

HPE ML350 Gen10 Intel Xeon-Platinum 8164 (2.0GHz/26-core/150W) Processor Kit 878658-B21

NOTE: Ships with Performance Heatsink.

HPE ML350 Gen10 Intel Xeon-Platinum 8160M (2.1GHz/24-core/150W) Processor Kit 878664-B21

NOTE: Ships with Performance Heatsink.

HPE ML350 Gen10 Intel Xeon-Platinum 8160 (2.1GHz/24-core/150W) Processor Kit 878657-B21

NOTE: Ships with Performance Heatsink.

HPE ML350 Gen10 Intel Xeon-Platinum 8158 (3.0GHz/12-core/150W) Processor Kit 878656-B21

NOTE: Ships with Performance Heatsink.

HPE ML350 Gen10 Intel Xeon-Platinum 8156 (3.6GHz/4-core/105W) Processor Kit 878655-B21

HPE ML350 Gen10 Intel Xeon-Platinum 8153 (2.0GHz/16-core/125W) Processor Kit 878654-B21

NOTE: Ships with Performance Heatsink.

HPE ML350 Gen10 Intel Xeon-Gold 6154 (3.0GHz/18-core/200W) Processor Kit 878653-B21

HPE ML350 Gen10 Intel Xeon-Gold 6152 (2.1GHz/22-core/140W) Processor Kit 878652-B21

NOTE: Ships with Performance Heatsink.

HPE ML350 Gen10 Intel Xeon-Gold 6150 (2.7GHz/18-core/165W) Processor Kit 878651-B21

NOTE: Ships with Performance Heatsink.

HPE ML350 Gen10 Intel Xeon-Gold 6148 (2.4GHz/20-core/150W) Processor Kit 878650-B21

NOTE: Ships with Performance Heatsink.

HPE ML350 Gen10 Intel Xeon-Gold 6146 (3.2GHz/12-core/165W) Processor Kit 878649-B21

NOTE: Ships with Performance Heatsink.

HPE ML350 Gen10 Intel Xeon-Gold 6144 (3.5GHz/8-core/150W) Processor Kit 878648-B21

NOTE: Ships with Performance Heatsink.

HPE ML350 Gen10 Intel Xeon-Gold 6142M (2.6GHz/16-core/150W) Processor Kit 878647-B21

NOTE: Ships with Performance Heatsink.

HPE ML350 Gen10 Intel Xeon-Gold 6142 (2.6GHz/16-core/150W) Processor Kit 866558-B21

NOTE: Ships with Performance Heatsink.

Core Options

HPE ML350 Gen10 Intel Xeon-Gold 6140M (2.3GHz/18-core/140W) Processor Kit	866556-B21
NOTE: Ships with Performance Heatsink.	
HPE ML350 Gen10 Intel Xeon-Gold 6140 (2.3GHz/18-core/140W) Processor Kit	866554-B21
NOTE: Ships with Performance Heatsink.	
HPE ML350 Gen10 Intel Xeon-Gold 6138 (2.0GHz/20-core/125W) Processor Kit	866552-B21
HPE ML350 Gen10 Intel Xeon-Gold 6136 (3.0GHz/12-core/150W) Processor Kit	866550-B21
NOTE: Ships with Performance Heatsink.	
HPE ML350 Gen10 Intel Xeon-Gold 6134M (3.2GHz/8-core/130W) Processor Kit	880215-B21
NOTE: Ships with Performance Heatsink.	
HPE ML350 Gen10 Intel Xeon-Gold 6134 (3.2GHz/8-core/130W) Processor Kit	880214-B21
NOTE: Ships with Performance Heatsink.	
HPE ML350 Gen10 Intel Xeon-Gold 6132 (2.6GHz/14-core/140W) Processor Kit	866548-B21
NOTE: Ships with Performance Heatsink.	
HPE ML350 Gen10 Intel Xeon-Gold 6130 (2.1GHz/16-core/125W) Processor Kit	866546-B21
HPE ML350 Gen10 Intel Xeon-Gold 6128 (3.4GHz/6-core/115W) Processor Kit	866544-B21
NOTE: Ships with Performance Heatsink.	
HPE ML350 Gen10 Intel Xeon-Gold 6126 (2.6GHz/12-core/125W) Processor Kit	866542-B21
NOTE: Ships with Performance Heatsink.	
HPE ML350 Gen10 Intel Xeon-Gold 5122 (3.6GHz/4-core/105W) Processor Kit	866540-B21
NOTE: Ships with Performance Heatsink.	
HPE ML350 Gen10 Intel Xeon-Gold 5120 (2.2GHz/14-core/105W) Processor Kit	866538-B21
NOTE: Ships with Performance Heatsink.	
HPE ML350 Gen10 Intel Xeon-Gold 5118 (2.3GHz/12-core/105W) Processor Kit	866536-B21
NOTE: Ships with Performance Heatsink.	
HPE ML350 Gen10 Intel Xeon-Gold 5115 (2.4GHz/10-core/85W) Processor Kit	866534-B21
HPE ML350 Gen10 Intel Xeon-Silver 4116 (2.1GHz/12-core/85W) Processor Kit	866532-B21
HPE ML350 Gen10 Intel Xeon-Silver 4114 (2.2GHz/10-core/85W) Processor Kit	866530-B21
HPE ML350 Gen10 Intel Xeon-Silver 4112 (2.6GHz/4-core/85W) Processor Kit	866528-B21
HPE ML350 Gen10 Intel Xeon-Silver 4110 (2.1GHz/8-core/85W) Processor Kit	866526-B21
HPE ML350 Gen10 Intel Xeon-Silver 4108 (1.8GHz/8-core/85W) Processor Kit	866524-B21
HPE ML350 Gen10 Intel Xeon-Bronze 3106 (1.7GHz/8-core/85W) Processor Kit	866522-B21
HPE ML350 Gen10 Intel Xeon-Bronze 3104 (1.7GHz/6-core/85W) Processor Kit	866520-B21

NOTE: Up to two processors supported. Performance Models include two processors.

NOTE: HT indicates that the processor model supports Intel® Hyper-Threading Technology.

NOTE: Turbo2: Intel® Turbo Boost Technology 2.0 provides more computing power when you need it with performance that adapts to spikes in your workload and delivers more performance upside than then previous generation turbo technology.

NOTE: DDR4 speed is the maximum memory speed of the processor. Actual memory speed may depend on the quantity and type of DIMMs installed.

NOTE: The xxxxxx-L21 is the first processor shipped, the xxxxxx-B21 is the 2nd processor and ships with the CPU heat sink for factory of field installation.

NOTE: Maximum memory per socket depends on the processor selected.

NOTE: Processors above 85W use a Performance Heatsink.

NOTE: 2P models require the Redundant Fan Cage kit (874572-B21) which consists of one fan cage along with 4 additional fans.

Core Options

Memory Selection

To streamline the configuration process for HPE ProLiant Gen10 servers and to provide the best product availability, HPE recommends memory from the list located here: <http://www.hpe.com/products/recommend>. Best product availability is limited to US, Canada, and Latin America at this time.

HPE Memory

HPE 8GB (1x8GB) Single Rank x8 DDR4-2666 CAS-19-19-19 Registered Smart Memory Kit	815097-B21
HPE 16GB (1x16GB) Single Rank x4 DDR4-2666 CAS-19-19-19 Registered Smart Memory Kit	815098-B21
HPE 16GB (1x16GB) Dual Rank x8 DDR4-2666 CAS-19-19-19 Registered Smart Memory Kit	835955-B21
HPE 32GB (1x32GB) Dual Rank x4 DDR4-2666 CAS-19-19-19 Registered Smart Memory Kit	815100-B21
HPE 64GB (1x64GB) Quad Rank x4 DDR4-2666 CAS-19-19-19 Load Reduced Smart Memory Kit	815101-B21
HPE 128GB (1x128GB) Octal Rank x4 DDR4-2666 CAS-22-19-19 3DS Load Reduced Memory Kit	815102-B21

NOTE: Memory DIMM availability with a server platform is dependent upon completion of certification testing.

NOTE: The maximum memory speed is a function of the memory type, memory configuration, and processor model.

HPE Optical Drives

HPE 9.5mm SATA DVD-ROM Optical Drive	726536-B21
--------------------------------------	------------

NOTE: The HPE ML350 Gen10 Slimline ODD Bay Kit (874577-B21) is required for this option.

HPE 9.5mm SATA DVD-RW Optical Drive	726537-B21
-------------------------------------	------------

NOTE: The HPE ML350 Gen10 Slimline ODD Bay Kit (874577-B21) is required for this option.

HPE Mobile USB DVD-RW Optical Drive	701498-B21
-------------------------------------	------------

NOTE: This is only supported on USB 3.0 ports.

NOTE: When front drive cages are fully populated (Box 1 – 3) and there is still the requirement for DVD-RW support, this external USB DVD-RW option will meet that need.

HPE Drives

Enterprise - 12G SAS - SFF Drives

HPE 300GB SAS 12G Enterprise 15K SFF (2.5in) SC 3yr Wty Digitally Signed Firmware HDD	870753-B21
HPE 300GB SAS 12G Enterprise 10K SFF (2.5in) SC 3yr Wty Digitally Signed Firmware HDD	872475-B21
HPE 600GB SAS 12G Enterprise 15K SFF (2.5in) SC 3yr Wty Digitally Signed Firmware HDD	870757-B21
HPE 600GB SAS 12G Enterprise 10K SFF (2.5in) SC 3yr Wty Digitally Signed Firmware HDD	872477-B21
HPE 900GB SAS 12G Enterprise 15K SFF (2.5in) SC 3yr Wty Digitally Signed Firmware HDD	870759-B21
HPE 900GB SAS 12G Enterprise 15K SFF (2.5in) SC 3yr Wty 512e Digitally Signed Firmware HDD	870765-B21

NOTE: HPE ML350 Gen10 Redundant Fan Cage Kit (874572-B21) is required for 10K, 15K or higher RPM SAS drives.

HPE 1.2TB SAS 12G Enterprise 10K SFF (2.5in) SC 3yr Wty Digitally Signed Firmware HDD	872479-B21
---	------------

HPE 1.8TB SAS 12G Enterprise 10K SFF (2.5in) SC 3yr Wty 512e Digitally Signed Firmware HDD	872481-B21
--	------------

HPE 2.4TB SAS 12G Enterprise 10K SFF (2.5in) SC 3yr Wty 512e Digitally Signed Firmware HDD	881457-B21
--	------------

NOTE: HPE ML350 Gen10 Redundant Fan Cage Kit (874572-B21) is required for 10K, 15K or higher RPM SAS drives.

Enterprise - 12G SAS - LFF Drives

HPE 300GB SAS 12G Enterprise 15K LFF (3.5in) LPC 3yr Wty Digitally Signed Firmware HDD	870755-B21
--	------------

HPE 900GB SAS 12G Enterprise 15K LFF (3.5in) LPC 3yr Wty Digitally Signed Firmware HDD	870761-B21
--	------------

Midline - 12G SAS - SFF Drives

HPE 1TB SAS 12G Midline 7.2K SFF (2.5in) SC 1yr Wty Digitally Signed Firmware HDD	832514-B21
---	------------

HPE 2TB SAS 12G Midline 7.2K SFF (2.5in) SC 1yr Wty 512e HDD	765466-B21
--	------------

HPE 1TB SAS 12G Midline 7.2K SFF (2.5in) SC 1yr Wty 512e Digitally Signed Firmware HDD	765464-B21
--	------------

Core Options

Midline - 12G SAS - LFF Drives

HPE 1TB SAS 12G Midline 7.2K LFF (3.5in) LP 1yr Wty Digitally Signed Firmware HDD	846526-B21
HPE 2TB SAS 12G Midline 7.2K LFF (3.5in) LP 1yr Wty Digitally Signed Firmware HDD	833926-B21
HPE 4TB SAS 12G Midline 7.2K LFF (3.5in) LP 1yr Wty 512e HDD	861748-B21
HPE 4TB SAS 12G Midline 7.2K LFF (3.5in) LP 1yr Wty Digitally Signed Firmware HDD	833928-B21
HPE 6TB SAS 12G Midline 7.2K LFF (3.5in) LP 1yr Wty 512e HDD	861746-B21
HPE 8TB SAS 12G Midline 7.2K LFF (3.5in) LP 1yr Wty 512e Digitally Signed Firmware HDD	834031-B21
HPE 10TB SAS 12G Midline 7.2K LFF (3.5in) LP 1yr Wty Helium 512e Digitally Signed Firmware HDD	857646-B21
HPE 12TB SAS 12G Midline 7.2K LFF (3.5in) LP 1yr Wty Helium 512e Digitally Signed Firmware HDD	881781-B21

Midline - 6G SATA - SFF Drives

HPE 1TB SATA 6G Midline 7.2K SFF (2.5in) SC 1yr Wty Digitally Signed Firmware HDD	655710-B21
HPE 2TB SATA 6G Midline 7.2K SFF (2.5in) SC 1yr Wty 512e Digitally Signed Firmware HDD	765455-B21

Midline - 6G SATA - LFF Drives

HPE 1TB SATA 6G Midline 7.2K LFF (3.5in) LP 1yr Wty Digitally Signed Firmware HDD	861686-B21
HPE 2TB SATA 6G Midline 7.2K LFF (3.5in) LP 1yr Wty Digitally Signed Firmware HDD	861681-B21
HPE 4TB SATA 6G Midline 7.2K LFF (3.5in) LP 1yr Wty Digitally Signed Firmware HDD	861683-B21
HPE 4TB SATA 6G Midline 7.2K LFF (3.5in) LP 1yr Wty 512e HDD	861744-B21
HPE 6TB SATA 6G Midline 7.2K LFF (3.5in) LP 1yr Wty 512e HDD	861742-B21
HPE 8TB SATA 6G Midline 7.2K LFF (3.5in) LP 1yr Wty 512e Digitally Signed Firmware HDD	834028-B21
HPE 10TB SATA 6G Midline 7.2K LFF (3.5in) LP 1yr Wty Helium 512e Digitally Signed Firmware HDD	857650-B21
HPE 12TB SATA 6G Midline 7.2K LFF (3.5in) LP 1yr Wty Helium 512e Digitally Signed Firmware HDD	881787-B21

6G SATA - LFF NHP/Raw Drives

HPE 1TB SATA 6G Midline 7.2K LFF (3.5in) RW 1yr Wty HDD	801882-B21
HPE 1TB SATA 6G Entry 7.2K LFF (3.5in) RW 1yr Wty HDD	843266-B21
HPE 4TB SATA 6G Midline 7.2K LFF (3.5in) RW 1yr Wty HDD	801888-B21

SSD Selection

To streamline the configuration process for HPE ProLiant Gen10 servers and to provide the best product availability, HPE recommends SSDs from the list located here: <http://www.hpe.com/products/recommend>.

Best product availability is limited to US, Canada, and Latin America at this time.

To further assist with configuration, HPE also offers an SSD Selector Tool located here: <http://ssd.hpe.com>.

Write Intensive – 12G SAS - SFF - Solid State Drives

HPE 400GB SAS 12G Write Intensive SFF (2.5in) SC 3yr Wty Digitally Signed Firmware SSD	873351-B21
HPE 800GB SAS 12G Write Intensive SFF (2.5in) SC 3yr Wty Digitally Signed Firmware SSD	873355-B21
HPE 1.6TB SAS 12G Write Intensive SFF (2.5in) SC 3yr Wty Digitally Signed Firmware SSD	873357-B21
HPE 400GB SAS WI SFF SC DS SSD	P04541-B21
HPE 800GB SAS WI SFF SC DS SSD	P04543-B21
HPE 1.6TB SAS WI SFF SC DS SSD	P04545-B21
HPE 3.2TB SAS WI SFF SC DS SSD	P04547-B21
HPE 400GB SAS WI SFF SC DS SSD	P09098-B21
HPE 800GB SAS WI SFF SC DS SSD	P09100-B21
HPE 1.6TB SAS WI SFF SC DS SSD	P09102-B21

Core Options

Read Intensive - 12G SAS - SFF - Solid State Drives

HPE 960GB SAS 12G Read Intensive SFF (2.5in) SC 3yr Wty Digitally Signed Firmware SSD	872390-B21
HPE 1.92TB SAS 12G Read Intensive SFF (2.5in) SC 3yr Wty Digitally Signed Firmware SSD	872392-B21
HPE 3.84TB SAS 12G Read Intensive SFF (2.5in) SC 3yr Wty Digitally Signed Firmware SSD	872394-B21
HPE 960GB SAS 12G Read Intensive SFF (2.5in) SC 3yr Wty Digitally Signed Firmware SSD	P06584-B21
HPE 1.92TB SAS 12G Read Intensive SFF (2.5in) SC 3yr Wty Digitally Signed Firmware SSD	P06586-B21
HPE 3.84TB SAS 12G Read Intensive SFF (2.5in) SC 3yr Wty Digitally Signed Firmware SSD	P06588-B21
HPE 7.68TB SAS 12G Read Intensive SFF (2.5in) SC 3yr Wty Digitally Signed Firmware SSD	P06590-B21
HPE 7.68TB SAS 12G Read Intensive SFF (2.5in) SC 3yr Wty Digitally Signed Firmware SSD	870144-B21
HPE 960GB SAS RI SFF SC DS SSD	P04517-B21
HPE 1.92TB SAS RI SFF SC DS SSD	P04519-B21
HPE 3.84TB SAS RI SFF SC DS SSD	P04521-B21
HPE 7.68TB SAS RI SFF SC DS SSD	P04523-B21

Read Intensive - 6G SATA - SFF - Solid State Drives

HPE 240GB SATA 6G Read Intensive SFF (2.5in) SC 3yr Wty Digitally Signed Firmware SSD	P04556-B21
HPE 240GB SATA 6G Read Intensive SFF (2.5in) SC 3yr Wty Digitally Signed Firmware SSD	875503-B21
HPE 240GB SATA 6G Read Intensive SFF (2.5in) SC 3yr Wty Digitally Signed Firmware SSD	877740-B21
HPE 480GB SATA 6G Read Intensive SFF (2.5in) SC 3yr Wty Digitally Signed Firmware SSD	P06194-B21
HPE 480GB SATA 6G Read Intensive SFF (2.5in) SC 3yr Wty Digitally Signed Firmware SSD	P04560-B21
HPE 480GB SATA 6G Read Intensive SFF (2.5in) SC 3yr Wty Digitally Signed Firmware SSD	875509-B21
HPE 480GB SATA 6G Read Intensive SFF (2.5in) SC 3yr Wty Digitally Signed Firmware SSD	877746-B21
HPE 960GB SATA 6G Read Intensive SFF (2.5in) SC 3yr Wty Digitally Signed Firmware SSD	P06196-B21
HPE 960GB SATA 6G Read Intensive SFF (2.5in) SC 3yr Wty Digitally Signed Firmware SSD	P04564-B21
HPE 960GB SATA 6G Read Intensive SFF (2.5in) SC 3yr Wty Digitally Signed Firmware SSD	875511-B21
HPE 1.92TB SATA 6G Read Intensive SFF (2.5in) SC 3yr Wty Digitally Signed Firmware SSD	P06198-B21
HPE 1.92TB SATA 6G Read Intensive SFF (2.5in) SC 3yr Wty Digitally Signed Firmware SSD	P04566-B21
HPE 1.92TB SATA 6G Read Intensive SFF (2.5in) SC 3yr Wty Digitally Signed Firmware SSD	875513-B21
HPE 480GB SATA 6G Read Intensive SFF (2.5in) SC 3yr Wty Digitally Signed Firmware SSD	P04474-B21
HPE 960GB SATA 6G Read Intensive SFF (2.5in) SC 3yr Wty Digitally Signed Firmware SSD	P04476-B21
HPE 1.92TB SATA 6G Read Intensive SFF (2.5in) SC 3yr Wty Digitally Signed Firmware SSD	P04478-B21
HPE 3.84TB SATA 6G Read Intensive SFF (2.5in) SC 3yr Wty Digitally Signed Firmware SSD	P04480-B21
HPE 3.84TB SATA 6G Read Intensive SFF (2.5in) SC 3yr Wty Digitally Signed Firmware SSD	P04570-B21
HPE 3.84TB SATA 6G Read Intensive SFF (2.5in) SC 3yr Wty Digitally Signed Firmware SSD	P06200-B21
HPE 7.68TB SATA 6G Read Intensive SFF (2.5in) SC 3yr Wty Digitally Signed Firmware SSD	P04482-B21

Read Intensive & Mixed Use - 6G SATA - LFF - Solid State Drives

HPE 1.92TB SATA 6G Mixed Use LFF (3.5in) LPC 3yr Wty Digitally Signed Firmware SSD	P03689-B21
HPE 1.92TB SATA 6G Mixed Use LPC (3.5in) SCC 3yr Wty Digitally Signed Firmware SSD	P03610-B21
HPE 1.92TB SATA 6G Mixed Use LFF (3.5in) LPC 3yr Wty Digitally Signed Firmware SSD	P07934-B21
HPE 480GB SATA 6G Read Intensive LFF (3.5in) LPC 3yr Wty Digitally Signed Firmware SSD	P04499-B21
HPE 1.92TB SATA 6G Read Intensive LFF (3.5in) LPC 3yr Wty Digitally Signed Firmware SSD	P04501-B21
HPE 960GB SATA RI LFF LPC DS SSD	P09691-B21
HPE 1.92TB SATA MU LFF LPC DS SSD	P09726-B21

Core Options

Mixed Use - 12G SAS - SFF - Solid State Drives

HPE 400GB SAS 12G Mixed Use SFF (2.5in) SC 3yr Wty Digitally Signed Firmware SSD	872374-B21
HPE 400GB SAS 12G Mixed Use SFF (2.5in) SC 3yr Wty Digitally Signed Firmware SSD	873359-B21
HPE 800GB SAS 12G Mixed Use SFF (2.5in) SC 3yr Wty Digitally Signed Firmware SSD	872376-B21
HPE 800GB SAS 12G Mixed Use SFF (2.5in) SC 3yr Wty Digitally Signed Firmware SSD	873363-B21
HPE 1.6TB SAS 12G Mixed Use SFF (2.5in) SC 3yr Wty Digitally Signed Firmware SSD	872382-B21
HPE 1.6TB SAS 12G Mixed Use SFF (2.5in) SC 3yr Wty Digitally Signed Firmware SSD	873365-B21
HPE 3.2TB SAS 12G Mixed Use SFF (2.5in) SC 3yr Wty Digitally Signed Firmware SSD	873367-B21
HPE 3.2TB SAS 12G Mixed Use SFF (2.5in) SC 3yr Wty Digitally Signed Firmware SSD	872386-B21
HPE 400GB SAS MU SFF SC DS SSD	P04525-B21
HPE 800GB SAS MU SFF SC DS SSD	P04527-B21
HPE 1.6TB SAS MU SFF SC DS SSD	P04533-B21
HPE 3.2TB SAS MU SFF SC DS SSD	P04537-B21
HPE 6.4TB SAS MU SFF SC DS SSD	P04539-B21
HPE 400GB SAS MU SFF SC DS SSD	P09088-B21
HPE 800GB SAS MU SFF SC DS SSD	P09090-B21
HPE 1.6TB SAS MU SFF SC DS SSD	P09092-B21
HPE 3.2TB SAS MU SFF SC DS SSD	P09094-B21
HPE 6.4TB SAS MU SFF SC DS SSD	P09096-B21

Mixed Use - 6G SATA - SFF - Solid State Drives

HPE 240GB SATA 6G Mixed Use SFF (2.5in) SC 3yr Wty Digitally Signed Firmware SSD	880295-B21
HPE 480GB SATA 6G Mixed Use SFF (2.5in) SC 3yr Wty Digitally Signed Firmware SSD	875470-B21
HPE 960GB SATA 6G Mixed Use SFF (2.5in) SC 3yr Wty Digitally Signed Firmware SSD	875474-B21
HPE 1.92TB SATA 6G Mixed Use SFF (2.5in) SC 3yr Wty Digitally Signed Firmware SSD	875478-B21
HPE 3.84TB SATA 6G Mixed Use SFF (2.5in) SC 3yr Wty Digitally Signed Firmware SSD	P00896-B21
HPE 480GB SATA 6G Mixed Use SFF (2.5in) SC 3yr Wty Digitally Signed Firmware SSD	P07922-B21
HPE 960GB SATA 6G Mixed Use SFF (2.5in) SC 3yr Wty Digitally Signed Firmware SSD	P07926-B21
HPE 1.92TB SATA 6G Mixed Use SFF (2.5in) SC 3yr Wty Digitally Signed Firmware SSD	P07930-B21
HPE 1.92TB SATA 6G Mixed Use SFF (2.5in) SC 3yr Wty Digitally Signed Firmware SSD	877788-B21
HPE 480GB SATA MU SFF SC DS SSD	P09712-B21
HPE 960GB SATA MU SFF SC DS SSD	P09716-B21
HPE 1.92TB SATA MU SFF SC DS SSD	P09722-B21

Mixed Use - 12G SAS - LFF - Solid State Drives

HPE 800GB SAS 12G Mixed Use LFF (3.5in) LPC 3yr Wty Digitally Signed Firmware SSD	872380-B21
HPE 1.6TB SAS 12G Mixed Use LFF (3.5in) LPC 3yr Wty Digitally Signed Firmware SSD	872384-B21
HPE 800GB SAS MU LFF LPC DS SSD	P04531-B21
HPE 1.6TB SAS MU LFF LPC DS SSD	P04535-B21

Mixed Use - 6G SATA - M.2 - Solid State Drives

HPE 240GB SATA 6G Mixed Use M.2 2280 3yr Wty Digitally Signed Firmware SSD	875488-B21
HPE 480GB SATA 6G Mixed Use M.2 2280 3yr Wty Digitally Signed Firmware SSD	875490-B21
HPE 960GB SATA 6G Mixed Use M.2 2280 3yr Wty Digitally Signed Firmware SSD	875492-B21

NOTE: Requires the M.2 universal enablement card kit (878783-B21) and use S100i SATA controller only.

NOTE: M.2 supports Software RAID only.

NOTE: HPE ML350 Gen10 Redundant Fan Cage Kit (874572-B21) is required for M.2 drives.

NOTE: HPE ML350 Gen10 NVMe 8SFF Exp Bay Kit (874569-B21) is required to support these drives.

NOTE: Max. support is one Gen10 ML350 NVMe 8SFF Exp Bay Kit (874569-B21) which can support up to 8 NVMe solid state drives.

NOTE: NVMe support is limited in SFF systems.

NOTE: NVMe drives require the addition of HPE ML350 Gen10 Redundant Fan Cage Kit (874572-B21).

Core Options

NOTE: When used to run high-performance workloads, NVMe SSDs can cause the fans to operate at high speeds to maintain optimum system cooling. This high-speed fan operation leads to a sound pressure level of between 50 dB(A) to 55 dB(A). Hewlett Packard Enterprise recommends taking this possible acoustic condition into consideration when selecting a site for a server that has NVMe SSDs installed.

NOTE: Not supported by HPE Smart Array controllers.

NOTE: HPE has qualified the NVMe drive portfolio using the Operating System inbox drivers, full detail on the

HPE Solid State Drive QuickSpecs

Read Intensive - 6G SATA - M.2 - Solid State Drives

HPE 480GB SATA 6G Read Intensive M.2 2280 3yr Wty Digitally Signed Firmware SSD

HPE 960GB SATA 6G Read Intensive M.2 2280 3yr Wty Digitally Signed Firmware SSD

NOTE: HPE Universal SATA HHL 3yr Wty M.2 Kit (878783-B21) and use S100i SATA controller c

NOTE: M.2 supports Software RAID only.

NOTE: HPE ML350 Gen10 Redundant Fan Cage Kit (874572-B21) is required for M.2 drives.

NVMe - SFF - Solid State Drives

HPE 375GB NVMe x4 Lanes Write Intensive SFF (2.5in) SCN 3yr Wty Digitally Signed Firmware SSD 878014-B21

HPE 400GB NVMe x4 Lanes Mixed Use SFF (2.5in) SCN 3yr Wty Digitally Signed Firmware SSD 875593-B21

HPE 480GB NVMe x4 Lanes Read Intensive SFF (2.5in) SCN 3yr Wty Digitally Signed Firmware SSD 875587-B21

HPE 800GB NVMe x4 Lanes Mixed Use SFF (2.5in) SCN 3yr Wty Digitally Signed Firmware SSD 875595-B21

HPE 960GB NVMe x4 Lanes Read Intensive SFF (2.5in) SCN 3yr Wty Digitally Signed Firmware SSD 875589-B21

HPE 1.6TB NVMe x4 Lanes Mixed Use SFF (2.5in) SCN 3yr Wty Digitally Signed Firmware SSD 875597-B21

HPE 1.92TB NVMe x4 Lanes Read Intensive SFF (2.5in) SCN 3yr Wty Digitally Signed Firmware SSD 875591-B21

HPE 4TB NVMe x4 Lanes Read Intensive SFF (2.5in) SCN 3yr Wty Digitally Signed Firmware SSD 877988-B21

HPE 1.6TB NVMe x4 MU SFF SCN DS SSD P10222-B21

HPE 1.92TB NVMe x4 RI SFF SCN DS SSD P10214-B21

NOTE: HPE ML350 Gen10 8SFF NVMe SSD Express Bay Enablement Kit with 2x4NVMe Risers and Support Cables (874569-B21) is required to support installation of these drives.

NOTE: Max. support is one Gen10 ML350 NVMe 8SFF Exp Bay Kit (874569-B21) which can support up to 8 NVMe solid state drives.

NOTE: NVMe support is limited in SFF systems.

NOTE: NVMe drives require the addition of HPE ML350 Gen10 Redundant Fan Cage Kit (874572-B21).

NOTE: When used to run high-performance workloads, NVMe SSDs can cause the fans to operate at high speeds to maintain optimum system cooling. This high-speed fan operation leads to a sound pressure level of between 50 dB(A) to 55 dB(A). Hewlett Packard Enterprise recommends taking this possible acoustic condition into consideration when selecting a site for a server that has NVMe SSDs installed.

NOTE: Not supported by HPE Smart Array controllers.

NOTE: HPE has qualified the NVMe drive portfolio using the Operating System inbox drivers, full detail on the HPE Solid State Drive QuickSpecs.

Hard Drive Blank Kits

HPE Small Form Factor Hard Drive Blank Kit 666987-B21

HPE Gen9 LFF HDD Spade Blank Kit 807878-B21

Hard Drive Kits

HPE ML350 Gen10 8SFF Hot Plug Drive Backplane Cage Kit 874568-B21

NOTE: Add add'l 8 SFF Hot-Plug Hard Drive Cage, allowing for up to 24 SFF Drive support (8+8+8).

HPE ML350 Gen10 4LFF Hot Plug Drive Backplane Cage Kit 874566-B21

NOTE: Add add'l 4 LFF Hot-Plug Hard Drive Cage, allowing for up to 12 LFF Drive support (4+4+4).

HPE ML350 Gen10 4LFF Non Hot Plug Drive Cage Kit 874567-B21

NOTE: Field upgrade only. Add add'l 4 LFF Non-Hot-Plug Hard Drive Cage, allowing for up to 12 LFF Drive support (4+4+4). NHP drive cage is for NHP server only.

HPE Universal SATA HHL 3yr Wty M.2 Kit 878783-B21

Core Options

NOTE: HPE M.2 universal enablement card kit (878783-B21), which is required for SATA M.2 support.

NOTE: Installation of this M.2 enablement card kit is limited to PCIe slot 1, 2, 3 or 4. Max. in ML350 Gen10 is one M.2 enablement card kit.

NOTE: HPE ML350 Gen10 Redundant Fan Cage Kit (874572-B21) is required when this card kit is selected/installed for M.2 SSD support.

HPE ML350 Gen10 8SFF NVMe SSD Express Bay Enablement Kit with 2x4NVMe Risers and Support Cables 874569-B21

NOTE: This kit contains two x4 Direct Attach PCIe NVMe Riser Boards with each supporting up to 4 NVMe drives. When both Risers are installed, it supports 8 SFF NVMe drives.

NOTE: Max. support is one Gen10 ML350 NVMe 8SFF Exp Bay Kit (874569-B21) with installation limited to Box 2 based on cable routing requirement.

NOTE: SFF NVMe SSDs to be ordered separately.

NOTE: NVMe support is limited in SFF systems.

NOTE: NVMe drives require the addition of HPE ML350 Gen10 Redundant Fan Cage Kit (874572-B21).

Media/ODD Bay Kits

HPE ML350 Gen10 RDX/LTO Media Drive Support Cable Kit with Fan Blank for Long LTO 874570-B21

NOTE: Supporting cables to add additional RDX/tape devices for data backup or archiving.

NOTE: RDX/tape devices to be ordered separately.

NOTE: In the case when LTO Internal Tape is selected along with the Fan Redundant Kit, Fan#1 will need to be removed and the Fan Blank provided in this option kit will need to be installed in Fan#1 location. This configuration will run without fan redundancy. Refer to [ML350 Gen10 User Guide](#) for more detail.

HPE ML350 Gen10 Slimline ODD Bay and Support Cable Kit 874577-B21

NOTE: Mechanical converter with supporting cable.

HPE Networking

1 Gigabit Ethernet adapters

HPE Ethernet 1Gb 4-port 331T Adapter 647594-B21

HPE Ethernet 1Gb 4-port 366T Adapter 811546-B21

HPE Ethernet 1Gb 2-port 332T Adapter 615732-B21

HPE Ethernet 1Gb 2-port 361T Adapter 652497-B21

10 Gigabit Ethernet adapters

HPE Ethernet 10Gb 2-port 530T Adapter 656596-B21

HPE Ethernet 10Gb 2-port 535T Adapter 813661-B21

HPE Ethernet 10Gb 2-port 530SFP Adapter 652503-B21

HPE Ethernet 10Gb 2-port 521T Adapter 867707-B21

NOTE: HPE ML350 Gen10 Redundant Fan Cage Kit with 4 Fan Modules (874572-B21) is required.

HPE Ethernet 10Gb 2-port 562T Adapter 817738-B21

HPE Ethernet 10Gb 2-port 562SFP+ Adapter 727055-B21

25 Gigabit Ethernet adapters

HPE Ethernet 10/25Gb 2-port 631SFP28 Adapter 817718-B21

HPE Ethernet 10/25Gb 2-port 640SFP28 Adapter 817753-B21

HPE Ethernet 10/25Gb 2-port 621SFP28 Adapter 867328-B21

NOTE: HPE ML350 Gen10 Redundant Fan Cage Kit with 4 Fan Modules (874572-B21) is required.

Core Options

HPE InfiniBand

HPE 100Gb 1-port OP101 QSFP28 x16 PCIe Gen3 with Intel Omni-Path Architecture Adapter 829335-B21

NOTE: HPE ML350 Gen10 Redundant Fan Cage Kit with 4 Fan Modules (874572-B21) is required to support this card.

HPE InfiniBand FDR/Ethernet 10Gb/40Gb 2-port 544+QSFP Adapter 764284-B21

HPE InfiniBand EDR/Ethernet 100Gb 1-port 840QSFP28 Adapter 825110-B21

NOTE: HPE ML350 Gen10 Redundant Fan Cage Kit with 4 Fan Modules (874572-B21) is required to support this card.

HPE InfiniBand EDR/Ethernet 100Gb 2-port 840QSFP28 Adapter 825111-B21

NOTE: HPE ML350 Gen10 Redundant Fan Cage Kit with 4 Fan Modules (874572-B21) is required to support this card.

HPE Ethernet 100Gb 1-port 842QSFP28 Adapter 874253-B21

NOTE: HPE ML350 Gen10 Redundant Fan Cage Kit with 4 Fan Modules (874572-B21) is required to support this card.

HPE Power Supplies

HPE 500W Flex Slot Platinum Hot Plug Low Halogen Power Supply Kit 865408-B21

NOTE: Flex Slot Platinum power supplies support power efficiency of up to 94% and include a standard C-14 power inlet connector.

HPE 800W Flex Slot Titanium Hot Plug Low Halogen Power Supply Kit 865438-B21

NOTE: Flex Slot Titanium power supplies support power efficiency of up to 96% and include a standard C-14 power inlet connector.

HPE 800W Flex Slot Platinum Hot Plug Low Halogen Power Supply Kit 865414-B21

NOTE: Flex Slot Platinum power supplies support power efficiency of up to 94% and include a standard C-14 power inlet connector.

HPE 800W Flex Slot -48VDC Hot Plug Low Halogen Power Supply Kit 865434-B21

NOTE: Flex Slot -48VDC power supplies support power efficiency of up to 94%.

HPE 800W Flex Slot Universal Hot Plug Low Halogen Power Supply Kit 865428-B21

NOTE: Flex Slot universal power supplies support power efficiency of up to 94% and support both 277VAC/380VDC power inputs.

HPE 1600W Flex Slot Platinum Hot Plug Low Halogen Power Supply Kit 830272-B21

NOTE: Available in 94% efficiency.

HPE 500W Low Halogen FIO Power Supply Kit 837074-B21

NOTE: Support power efficiency of up to 92%.

HPE Power Supply Options

HPE ML350 Gen10 Flex Slot Redundant Power Supply Cage Kit with Power Distribution Board 874571-B21

NOTE: Field upgrade only. Allowing field upgrade from the 500W standard PSU/non-RPS, non-hot-plug to support HPE Flex Slot RPS.

Core Options

GPGPU Information											
Part Number	Card	TDP	Qty. Support	PCIe Speed	ML350 Gen10 Configuration						
					8SFF	16SFF	16SFF+8NVMe	24SFF	4LFF	8LFF	12LFF
Q0V77A	HPE NVIDIA Quadro P2000 GPU Module	75W	4	Gen3	35C	35C	35C	35C	35C	35C	35C
Q0V78A	HPE NVIDIA Quadro P4000 GPU Module	105W	4	Gen3	35C	35C	35C	35C	35C	35C	35C
Q0V76A	HPE NVIDIA Quadro P6000 GPU Module	250W	4	Gen3	35C	35C	35C	35C	35C	35C	35C
Q0J62A	HPE NVIDIA Tesla M10 Quad GPU Module	225W	2	Gen3	35C	30C	30C	30C	30C	30C	30C
Q0V80A	HPE NVIDIA Tesla P40 24 GB Module	250W	4	Gen3	25C	20C	20C	20C	20C	20C	20C
Q1K34A	HPE NVIDIA Quadro GV100 GPU Module	250W	4	Gen3	20C/30C*	20C/30C*	20C	20C	20C	20C/30C*	20C
Q2N67A	HPE NVIDIA GV100 Nvlink Bridge Kit	n/a	4	NVLin k	n/a	n/a	n/a	n/a	n/a	n/a	n/a

NOTE: The 1600W RPS is recommended when the system is configured with high power GPU. The 800W RPS will work too (per GPU) – depending on configuration. Please do check the total power requirement of your selected configuration with the GPU(s) supported in this platform with the HPE Power Advisor Tool located at <http://www.hpe.com/info/hppoweradvisor>.

NOTE: The ML350 Gen10 Redundant Fan Cage Kit (874572-B21) is required for ALL GPU installations. (Note, the redundant fan kit ships as standard with the two 2P Performance models and the Rack CTO).

NOTE: Mixing of GPUs is not supported.

NOTE: These GPUs are not recommended for use in office environment especially under stress mode when system fans are running at full speed.

NOTE: HPE ML350 Gen10 GPU Ext Power Cable Kit (877628-B21) is required for GPU TDP larger than 75W – that is, this GPU external power cable kit is required except for HPE NVIDIA Quadro P2000 (Q0V77A).

NOTE: * Higher ambient temps are supported with “increased cooling” statically set in the RBSU.

HPE Computation and Graphics Accelerators

HPE NVIDIA Quadro P2000 Graphics Accelerator

Q0V77A

NOTE: HPE ML350 Gen10 Redundant Fan Cage Kit (874572-B21) is required.

HPE NVIDIA Quadro P4000 Graphics Accelerator

Q0V78A

NOTE: HPE ML350 Gen10 GPU External Power Cable Kit (877628-B21) is required.

NOTE: HPE ML350 Gen10 Redundant Fan Cage Kit (874572-B21) is required.

HPE NVIDIA Quadro P6000 Graphics Accelerator

Q0V76A

NOTE: HPE ML350 Gen10 GPU External Power Cable Kit (877628-B21) is required.

NOTE: HPE ML350 Gen10 Redundant Fan Cage Kit (874572-B21) is required.

HPE NVIDIA Quadro GV100 Graphics Accelerator

Q1K34A

NOTE: HPE ML350 Gen10 GPU External Power Cable Kit (877628-B21) is required.

NOTE: HPE ML350 Gen10 Redundant Fan Cage Kit (874572-B21) is required.

Core Options

HPE NVIDIA GV100 Nvlink Bridge Kit	Q2N67A
NOTE: Used to combine 2 HPE NVIDIA Quadro GV100 GPU modules. 2 HPE NVIDIA GV100 Nvlink Bridge Kits are required for every pair of GV100-32GB PCIE cards.	
NVIDIA Tesla M10 Quad GPU Module	Q0J62A
NOTE: HPE ML350 Gen10 GPU External Power Cable Kit (877628-B21) is required.	
NOTE: HPE ML350 Gen10 Redundant Fan Cage Kit (874572-B21) is required.	
HPE NVIDIA Tesla P40 24GB Computational Accelerator	Q0V80A
NOTE: HPE ML350 Gen10 GPU External Power Cable Kit (877628-B21) is required.	
NOTE: HPE ML350 Gen10 Redundant Fan Cage Kit (874572-B21) is required.	

Graphics Cable Kits

HPE ML350 Gen10 GPU External Power Cable Kit	877628-B21
NOTE: This kit consists of two external power cables to feed power to GPU modules with TDP larger than 75W that is, this GPU external power cable kit is required except for HPE NVIDIA Quadro P2000 (Q0V77A). The longer GPU power cable is intended to support GPU installation in PCIe slot 1 or 3 (slots coming from CPU 1); while the other shorter cable to support slot 5 or 7 (slots coming from CPU 2).	

PCIe Accelerators

HPE 1.6TB PCIe x8 Lanes Mixed Use HHHHL 3yr Wty Digitally Signed Firmware Card	877825-B21
NOTE: HPE ML350 Gen10 Redundant Fan Cage Kit with 4 Fan Modules (874572-B21) is required.	
HPE 3.2TB PCIe x8 Lanes Mixed Use HHHHL 3yr Wty Digitally Signed Firmware Card	877827-B21
NOTE: HPE ML350 Gen10 Redundant Fan Cage Kit with 4 Fan Modules (874572-B21) is required.	
HPE 6.4TB PCIe x8 Lanes Mixed Use HHHHL 3yr Wty Digitally Signed Firmware Card	877829-B21
NOTE: HPE ML350 Gen10 Redundant Fan Cage Kit with 4 Fan Modules (874572-B21) is required.	

HPE Cooling Options

HPE ML350 Gen10 Redundant Fan Cage Kit with 4 Fan Modules	874572-B21
NOTE: This kit is required for elevated Ambient temperature environments.	
NOTE: Add add'l 4x hot-plug fans which are installed in the fan cage to get N+1 fan redundancy and advanced cooling.	
NOTE: The performance 2P BTO models and the Rack CTO model will already include this kit to include 6 fans total.	
NOTE: The ML350 Gen10 Redundant Fan Kit (874572-B21) is required for one of the following configurations or situations: 2P configuration.	
When the unit is configured to use in Rack mode.	
When front storage is fully populated with (3) 4LFF or (3) 8SFF drive cages or (2) LFF or SFF drive cages along with (2) media bays and (1) DVD.	
When ML350 Gen10 is used in ASHRAE 3 or 4 environment.	
When the unit is configured with higher RPM SAS HDDs (10K, 15K or higher).	
When the unit is configured with NVMe Express Bay for NVMe SSD support.	
When M.2 is selected.	
The ML350 Gen10 Redundant Fan Cage Kit is also needed to support certain higher end PCIe expansion cards for example, GPU (Graphic Processing Unit), advanced PCIe accelerators, InfiniBand cards, higher-end network adapters and storage controllers P816i-a and P824i-pcontroller.	
NOTE: Please refer to the User Guide for special configuration scenarios where the redundant fan option is required but does not provide redundancy function.	

Additional Options

NOTE: Some options may not be integrated at the factory. To ensure only valid configurations are ordered, Hewlett Packard Enterprise recommends the use of an HPE approved configurator. Contact your local sales representative for additional information.

Embedded Management

HPE iLO Advanced

HPE iLO Advanced Electronic License with 1yr Support on iLO Licensed Features	E6U59ABE
HPE iLO Advanced 1-server License with 1yr Support on iLO Licensed Features	512485-B21
HPE iLO Advanced Flexible Quantity License with 1yr Support on iLO Licensed Features	512486-B21
HPE iLO Advanced AKA Tracking License with 1yr Support on iLO Licensed Features	512487-B21
HPE iLO Advanced Electronic License with 3yr Support on iLO Licensed Features	E6U64ABE
HPE iLO Advanced 1-server License with 3yr Support on iLO Licensed Features	BD505A
HPE iLO Advanced Flexible Quantity License with 3yr Support on iLO Licensed Features	BD506A
HPE iLO Advanced AKA Tracking License with 3yr Support on iLO Licensed Features	BD507A

HPE Converged Infrastructure Management Software

HPE OneView Physical Media Kit LTU	E5Y37A
HPE OneView including 3yr 24x7 Support Physical 1-server LTU	E5Y34A
HPE OneView including 3yr 24x7 Support Flexible Quantity E-LTU	E5Y35AAE
HPE OneView w/o iLO including 3yr 24x7 Support Track 1-server LTU	P8B25A

NOTE: Licenses ship without media. The HPE OneView Media Kit can be ordered separately, or can be **downloaded**.

HPE Security

HPE Trusted Platform Module 2.0 Gen10 Option	864279-B21
--	------------

NOTE: HPE Trusted Platform Module 2.0 option works with Gen10 servers with UEFI Mode not Legacy Mode. It is not compatible with HPE ProLiant Gen8 servers or earlier generation variants.

NOTE: HPE server systems can have a TPM module (of any type) installed only once. It cannot be replaced with any other TPM module.

NOTE: There is a FIO setting to allow this TPM module to operate in a TPM 1.2 mode (872108-B21).

HPE Gen10 TPM 1.2 FIO Setting	872108-B21
-------------------------------	------------

HPE Smart Array Controllers

The Gen10 controller naming framework has been updated to simplify identification as depicted below. For a more detailed breakout of the available Gen10 Smart Array controllers visit the [HPE Smart Array Gen10 Controllers Data Sheet](#).

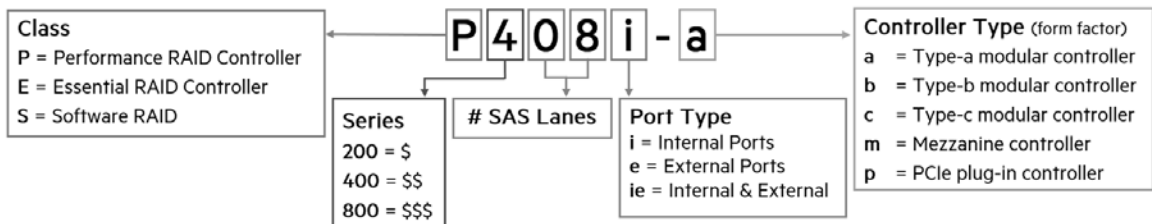

Additional Options

Performance RAID Controllers

NOTE: All performance RAID controllers are supported by the HPE Smart Storage Battery (P01367-B21), which supports multiple devices and is sold separately.

HPE Smart Array P816i-a SR Gen10 (16 Internal Lanes/4GB Cache/SmartCache) 12G SAS Modular Controller 804338-B21

NOTE: Does not occupy a PCIe expansion slot and includes SmartCache license.

NOTE: HPE ML350 Gen10 SFF AROC Cable Kit (877575-B21) for SFF chassis configuration or HPE ML350 Gen10 LFF AROC Cable Kit (874573-B21) for LFF chassis configuration is required.

NOTE: HPE ML350 Gen10 Redundant Fan Cage Kit (874572-B21) is required for P816i-a.

NOTE: For information on the HPE Smart Array P816i-a SR Gen10 Controller please refer to their [QuickSpecs](#).

HPE Smart Array P408i-a SR Gen10 (8 Internal Lanes/2GB Cache) 12G SAS Modular Controller 804331-B21

NOTE: Does not occupy a PCIe expansion slot.

NOTE: HPE ML350 Gen10 SFF AROC Cable Kit (877575-B21) for SFF chassis configuration or HPE ML350 Gen10 LFF AROC Cable Kit (874573-B21) for LFF chassis configuration is required.

NOTE: For information on the HPE Smart Array P408i-a SR Gen10 Controller please refer to their [QuickSpecs](#).

HPE Smart Array P408i-p SR Gen10 (8 Internal Lanes/2GB Cache) 12G SAS PCIe Plug-in Controller 830824-B21

NOTE: HPE ML350 Gen10 Smart Array/HBA Mini-SAS Cable Kit for SFF Configuration (874575-B21) for SFF chassis configuration or HPE ML350 Gen10 LFF SA/HBA Cable Kit (874574-B21) for LFF chassis configuration is required.

NOTE: For information on the HPE Smart Array P408i-p SR Gen10 Controller please refer to their [QuickSpecs](#).

HPE Smart Array P408e-p SR Gen10 (8 External Lanes/4GB Cache) 12G SAS PCIe Plug-in Controller 804405-B21

NOTE: For information on the HPE Smart Array P408e-p SR Gen10 Controller please refer to their [QuickSpecs](#).

HPE Smart Array P824i-p MR Gen10 (24 Internal Lanes/4GB Cache/CacheCade) 12G SAS PCIe Controller 870658-B21

NOTE: HPE D38X/580/560/ML350 24P Cable Kit (P00614-B21) is required when this controller is selected.

NOTE: HPE ML350 Gen10 Redundant Fan Cage Kit (874572-B21) is required for P824i-p.

NOTE: This controller is supported in ML350 Gen10 SFF configurations only supporting up to 24 SAS/SATA drives.

NOTE: For information on the HPE Smart Array P824i-p MR Gen10 Controller, please refer to their [QuickSpecs](#).

Essential RAID Controllers

HPE Smart Array E208i-p SR Gen10 (8 Internal Lanes/No Cache) 12G SAS PCIe Plug-in Controller 804394-B21

NOTE: HPE ML350 Gen10 Smart Array/HBA Mini-SAS Cable Kit for SFF Configuration (874575-B21) for SFF chassis configuration or HPE ML350 Gen10 LFF SA/HBA Cable Kit (874574-B21) for LFF chassis configuration is required.

NOTE: For information on the HPE Smart Array E208i-p SR Gen10 Controller please refer to their [QuickSpecs](#).

HPE Smart Array E208e-p SR Gen10 (8 External Lanes/No Cache) 12G SAS PCIe Plug-in Controller 804398-B21

NOTE: For information on the HPE Smart Array E208e-p SR Gen10 Controller please refer to their [QuickSpecs](#).

Essential RAID Controllers

HPE Smart Array E208i-a SR Gen10 (8 Internal Lanes/No Cache) 12G SAS Modular Controller 804326-B21

NOTE: Does not occupy a PCIe expansion slot.

NOTE: HPE ML350 Gen10 SFF AROC Cable Kit (877575-B21) for SFF chassis configuration or HPE ML350 Gen10 LFF AROC Cable Kit (874573-B21) for LFF chassis configuration is required.

Additional Options

NOTE: For information on the HPE Smart Array E208i-a SR Gen10 Controller please refer to their [QuickSpecs](#).

Additional Options

HPE Cable Options and SAS Expander Kit

HPE ML350 Gen10 Embedded SATA Cable Kit for LFF Configuration 877578-B21

NOTE: This cable kit is used to support the embedded SATA controller with S100i SW RAID. One cable kit per HDD cage.

HPE ML350 Gen10 Embedded SATA Cable Kit for SFF Configuration 877579-B21

NOTE: This cable kit is used to support the embedded SATA controller with S100i SW RAID. One cable kit per HDD cage.

HPE ML350 Gen10 AROC Mini-SAS Cable Kit for LFF Configuration 874573-B21

HPE ML350 Gen10 AROC Mini-SAS Cable Kit for SFF Configuration 877575-B21

HPE ML350 Gen10 Smart Array/HBA Mini-SAS Cable Kit for LFF Configuration 874574-B21

HPE ML350 Gen10 Smart Array/HBA Mini-SAS Cable Kit for SFF Configuration 874575-B21

HPE DL38X/560/580/ML350 Gen10 P824i-p Cable Kit P00614-B21

NOTE: This cable kit must be selected when P824i-p card is ordered. One P824i-p requires one cable kit.

NOTE: For details on cabling options and cable routing instructions, refer to **HPE ML350 Gen10 User Guide**.

HPE ML350 Gen10 12Gb SAS Expander Card Kit with Cables 874576-B21

NOTE: Add this SAS Expander option kit to upgrade your ML350 Gen10 SFF system pre-configured with either P408i-a or E208i-a (or any P or E-series card), to support 24 SFF drives.

Optional Software

HPE Smart Array SR Secure Encryption (Data at Rest Encryption/per Server Entitlement) E-LTU Q2F26AAE

HPE Smart Array SR SmartCache (Single Key/Single Server) LTU D7S26A

HPE Smart Array SR SmartCache (Single Key/Multiple Servers) LTU D7S27A

HPE Smart Array SR SmartCache (Single Key/Multiple Servers) E-LTU D7S27AAE

NOTE: SmartCache is offered on HPE Smart Array performance RAID controllers and comes standard (no licensing is required) if the HPE Smart Array P816i-a SR Gen10 Controller is installed in the server.

Optional Upgrades

HPE 96W Smart Storage Battery (up to 20 Devices) with 260mm Cable Kit P01367-B21

NOTE: Provides backup power for multiple HPE Smart Array controllers or other devices. Is required with performance RAID controllers. This product replaces 875242-B21.

HPE Tape Backup

NOTE: Internal half-height (5.25") tape devices are supported in ML350 Gen10 and require the HPE ML350 Gen10 Media Drive Support Kit (874570-B21).

NOTE: In the case when LTO Internal Tape is selected along with the Fan Redundant Kit, Fan#1 will need to be removed and the Fan Blank provided in this option kit will need to be installed in Fan#1 location. This configuration will run without fan redundancy. Refer to **ML350 Gen10 User Guide** for more detail.

NOTE: Installation of the internal LTO tape drive is limited in media bay 1.

NOTE: For the complete range of tape drives, autoloaders, libraries and media see:

<https://www.hpe.com/us/en/storage/storeever-tape-storage.html>

For hardware and software compatibility of Hewlett Packard Enterprise tape backup products

<http://www.hpe.com/storage/BURACompatibility>

Additional Options

HPE Tape Drives

HPE LTO-7 Ultrium 15000 Internal Tape Drive	BB873A
HPE StoreEver LTO-7 Ultrium 15000 External Tape Drive	BB874A
HPE LTO-6 Ultrium 6250 Internal Tape Drive	EH969A
HPE StoreEver LTO-6 Ultrium 6250 External Tape Drive	EH970A
HPE StoreEver LTO-5 Ultrium 3000 SAS Internal Tape Drive	EH957B
HPE StoreEver LTO-5 Ultrium 3000 SAS External Tape Drive	EH958B

HPE Tape Drives

HPE StoreEver LTO-8 Ultrium 30750 Internal Tape Drive	BC022A
HPE StoreEver LTO-8 Ultrium 30750 External Tape Drive	BC023A

HPE Tape Backup Products

HPE StoreEver 1/8 G2 LTO-8 Ultrium 30750 FC Tape Autoloader	Q6Q65A
HPE StoreEver 1/8 G2 LTO-8 Ultrium 30750 SAS Tape Autoloader	Q6Q66A
HPE StoreEver MSL LTO-8 Ultrium 30750 FC Drive Upgrade Kit	Q6Q67A
HPE StoreEver MSL LTO-8 Ultrium 30750 SAS Drive Upgrade Kit	Q6Q68A
HPE StoreEver MSL3040 Scalable Library Base Module	Q6Q62A
HPE StoreEver MSL3040 Scalable Library Expansion Module	Q6Q63A
HPE StoreEver MSL LTO-7 Ultrium 15000 FC Drive Upgrade Kit	N7P36A
HPE StoreEver MSL LTO-7 Ultrium 15000 SAS Drive Upgrade Kit	N7P37A
HPE StoreEver MSL LTO-6 Ultrium 6250 SAS Drive Upgrade Kit	COH27A
HPE StoreEver MSL LTO-6 Ultrium 6250 Fibre Channel Drive Upgrade Kit	COH28A
HPE StoreEver MSL LTO-5 Ultrium 3000 SAS Drive Upgrade Kit	BL540B
HPE StoreEver MSL2024 0-drive Tape Library	AK379A
HPE StoreEver MSL4048 0-drive Tape Library	AK381A
HPE StoreEver MSL6480 Scalable Base Module	QU625A
HPE StoreEver 1/8 G2 LTO-7 Ultrium 15000 FC Tape Autoloader	N7P34A
HPE StoreEver 1/8 G2 LTO-7 Ultrium 15000 SAS Tape Autoloader	N7P35A
HPE StoreEver 1/8 G2 LTO-6 Ultrium 6250 SAS Tape Autoloader	COH18A
HPE StoreEver 1/8 G2 LTO-6 Ultrium 6250 Fibre Channel Tape Autoloader	COH19A
HPE StoreEver 1/8 G2 LTO-5 Ultrium 3000 SAS Tape Autoloader	BL536B
HPE StoreEver Mini-SAS High Density to 4-lane Mini-SAS External Fanout 2m Cable	K2R09A
HPE StoreEver Mini-SAS High Density to 4-lane Mini-SAS External Fanout 4m Cable	K2R10A

HPE RDX Products

HPE RDX+ 1TB External Backup System	B7B69B
HPE RDX+ External Docking System	C8S07B
HPE RDX+ 2TB External Backup System	E7X53B
HPE RDX 4TB USB Ext Disk Backup Sys	Q2R33A
HPE RDX+ 3TB USB 3.0 Ext Disk Backup Sys	P9L72A
HPE RDX 4TB Removable Disk Cartridge	Q2048A
HPE RDX 2TB Removable Disk Cartridge	Q2046A
HPE RDX 3TB Removable Disk Cartridge	Q2047A
HPE RDX 500GB Removable Disk Cartridge	Q2042A
HPE RDX 1TB Removable Disk Cartridge	Q2044A

Additional Options

HPE Storage Options

Emulex Fibre Channel HBAs

HPE StoreFabric SN1200E 16Gb Single Port Fibre Channel Host Bus Adapter	Q0L13A
HPE StoreFabric SN1200E 16Gb Dual Port Fibre Channel Host Bus Adapter	Q0L14A
HPE StoreFabric SN1600E 32Gb Single Port Fibre Channel Host Bus Adapter	Q0L11A
HPE StoreFabric SN1600E 32Gb Dual Port Fibre Channel Host Bus Adapter	Q0L12A

QLogic Fibre Channel HBAs

HPE StoreFabric SN1100Q 16Gb Single Port Fibre Channel Host Bus Adapter	P9D93A
HPE StoreFabric SN1100Q 16Gb Dual Port Fibre Channel Host Bus Adapter	P9D94A
HPE StoreFabric SN1600Q 32Gb Single Port Fibre Channel Host Bus Adapter	P9M75A
HPE StoreFabric SN1600Q 32Gb Dual Port Fibre Channel Host Bus Adapter	P9M76A

Converged Network Adapters

HPE StoreFabric CN1100R Dual Port Converged Network Adapter	QW990A
HPE StoreFabric CN1100R 10GBASE-T Dual Port Converged Network Adapter	N3U52A
HPE StoreFabric CN1200E 10GBASE-T Dual Port Converged Network Adapter	N3U51A
HPE StoreFabric CN1200E 10Gb Converged Network Adapter	E7Y06A
HPE StoreFabric CN1200R 10GBASE-T CNA	Q0F26A
HPE StoreFabric CN1300R 10/25Gb CNA	Q0F09A

NOTE: For the complete listing of Fibre Channel Host Bus Adapters for Windows 2000, Windows Server 2003 and Linux, please see: <https://www.hpe.com/us/en/product-catalog/servers/adapters.hits-12.html>.

HPE Racks

NOTE: Please see the [HPE Advanced Series Racks QuickSpecs](#) for information on additional racks options and rack specifications.

NOTE: Please see the [HPE Enterprise Series Racks QuickSpecs](#) for information on additional racks options and rack specifications.

NOTE: Please see the [HPE Standard Series Racks QuickSpecs](#) for information on additional racks options and rack specifications.

HPE Power Distribution Units (PDUs)

NOTE: Please see the [HPE Basic Power Distribution Units \(PDU\) QuickSpecs](#) for information on these products and their specifications.

NOTE: Please see the [HPE Metered Power Distribution Units \(PDU\) QuickSpecs](#) for information on these products and their specifications.

NOTE: Please see the [HPE Intelligent Power Distribution Unit \(PDU\) QuickSpecs](#) for information on these products and their specifications.

NOTE: Please see the [HPE Metered and Switched Power Distribution Units \(PDU\) QuickSpecs](#) for information on these products and their specifications.

HPE Uninterruptible Power Systems (UPS)

NOTE: To learn more, please visit the [HPE Uninterruptible Power Systems \(UPS\) web page](#)

NOTE: Please see the [HPE DirectFlow Three Phase Uninterruptible Power System QuickSpecs](#) for information on these products and their specifications.

NOTE: Please see the [HPE Line Interactive Single Phase UPS QuickSpecs](#) for information on these products and their specifications.

HPE Rack Options

NOTE: Please see the [HPE KVM Switches web page](#) for information on these products and their specifications.

Additional Options

Rail Kits

HPE ML Gen10 Tower to Rack Conversion Kit with Sliding Rail Rack Shelf and Cable Management Arm 874578-B21

NOTE: Easy install rack rail tray which takes up 1U height in a standard rack facility. This kit is supported in both ML350 and ML110 Gen10 for tower to rack conversion. This kit includes CMA and is shipped as standard in the 2P Performance Rack SKU and SFF Rack CTO.

HPE USB and SD Options

HPE Enterprise Mainstream Flash Media Kits for Memory Cards

HPE 32GB microSD Flash Memory Card 700139-B21

HPE 8GB microSD Flash Memory Card 726116-B21

HPE 8GB microSD Flash USB Drive 737953-B21

HPE 8GB Dual microSD Flash USB Drive 741279-B21

HPE Support Services

HPE 3 Year Proactive Care 24x7 ML350 Gen10 Service H9GF8E

HPE 3 Year Proactive Care 24x7 with DMR ML350 Gen10 Service H9GF9E

HPE 3 Year Proactive Care 24x7 with CDMR ML350 Gen10 Service H9GG0E

HPE 3 Year Proactive Care Call-To-Repair ML350 Gen10 Service H9GG7E

HPE 3 Year Proactive Care Call-To-Repair 24x7 with DMR ML350 Gen10 Service H9GG8E

HPE 3 Year Proactive Care Call-To-Repair with CDMR ML350 Gen10 Service H9GG9E

HPE Install ProLiant ML350(p) Service U4522E

HPE Installation and Startup ML350(p) Service U4523E

NOTE: For a full listing of support services available for this server, please visit <https://ssc.hpe.com/>

Memory

Memory Population guidelines

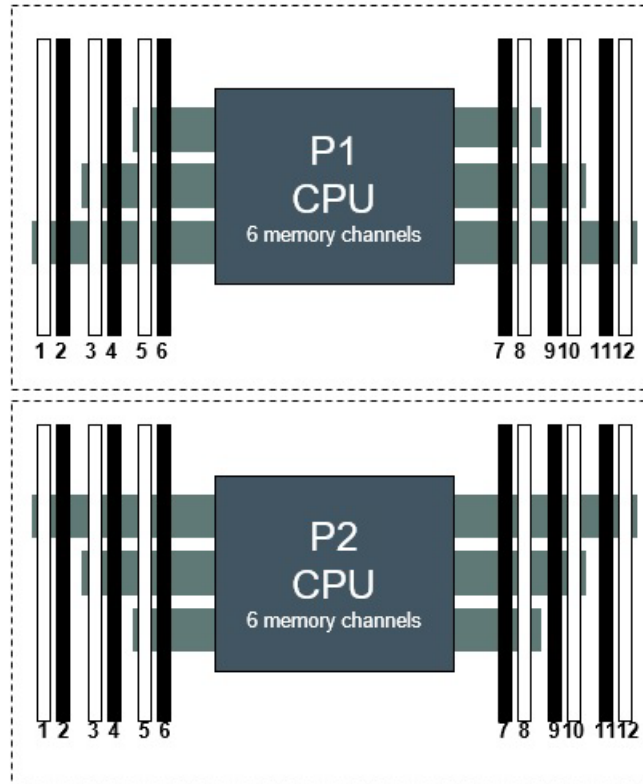

HPE ML350 Gen10 Server(Front Server)
2 Slots per channel

1 DIMM							8				
2 DIMMs							8	10			
3 DIMMs							8	10		12	
4 DIMMs			3		5		8	10			
5 DIMMs *			3		5		8	10		12	
6 DIMMs	1		3		5		8	10		12	
7 DIMMs *	1		3		5		7	8		10	12
8 DIMMs			3	4	5	6	7	8	9	10	
9 DIMMs *	1		3		5		7	8	9	10	11
10 DIMMs *	1		3	4	5	6	7	8	9	10	12
11 DIMMs *	1		3	4	5	6	7	8	9	10	11
12 DIMMs	1	2	3	4	5	6	7	8	9	10	11

HPE ProLiant Gen10 12 slot per CPU DIMM Population Order
*Unbalanced, not recommended

Memory

General Memory Population Rules and Guidelines:

- Install DIMMs only if the corresponding processor is installed.
- If only one processor is installed in a two-processor system, only half of the DIMM slots are available.
- To maximize performance, it is recommended to balance the total memory capacity between all installed processors.
- When two processors are installed, balance the DIMMs across the two processors.
- White DIMM slots denote the first slot to be populated in a channel.
- Mixing of DIMM types (UDIMM, RDIMM, and LRDIMM) is not supported.
- The maximum memory speed is a function of the memory type, memory configuration, and processor model.
- The maximum memory capacity is a function of the number of DIMM slots on the platform, the largest DIMM capacity qualified on the platform, the number and model of installed processors qualified on the platform.
- For details on the HPE Server Memory Options Population Rules, visit: <http://www.hpe.com/docs/memory-population-rules>.
- To realize the performance memory capabilities listed in this document, HPE DDR4 SmartMemory is required. For additional information, please see the [HPE DDR4 SmartMemory QuickSpecs](#).

DIMM Type	Register DIMM (RDIMM)			
HPE SKU P/N	815097-B21	815098-B21	835955-B21	815100-B21
SKU Description	HPE 8GB (1x8GB) Single Rank x8 DDR4-2666 CAS-19-19-19 Registered Smart Memory Kit	HPE 16GB (1x16GB) Single Rank x4 DDR4-2666 CAS-19-19-19 Registered Smart Memory Kit	HPE 16GB (1x16GB) Dual Rank x8 DDR4-2666 CAS-19-19-19 Registered Smart Memory Kit	HPE 32GB (1x32GB) Dual Rank x4 DDR4-2666 CAS-19-19-19 Registered Smart Memory Kit
DIMM Rank ->	Single Rank (1R)	Single Rank (1R)	Dual Rank (2R)	Dual Rank (2R)
DIMM Capacity ->	8GB	16GB	16GB	32GB
Voltage	1.2V	1.2V	1.2V	1.2V
DRAM depth [bit]	1G	2G	1G	2G
DRAM Width [bit]	x8	x4	x8	x4
DRAM Density	8Gb	8Gb	8Gb	8Gb
CAS Latency	19-19-19	19-19-19	19-19-19	19-19-19
DIMM Native Speed (MT/s)	2666 MT/s	2666 MT/s	2666 MT/s	2666 MT/s
Intel Xeon®Platinum 81xx/61xx Processors Officially Supported Memory Speed (MT/s)				
1 DIMM Per Channel	2666 MT/s	2666 MT/s	2666 MT/s	2666 MT/s
2 DIMM Per Channel	2666 MT/s	2666 MT/s	2666 MT/s	2666 MT/s
Intel Xeon®Platinum 41xx/51xx Processors Officially Supported Memory Speed (MT/s)				
1 DIMM Per Channel	2400 MT/s	2400 MT/s	2400 MT/s	2400 MT/s
2 DIMM Per Channel	2400 MT/s	2400 MT/s	2400 MT/s	2400 MT/s
Intel Xeon®Platinum 31xx Processors Officially Supported Memory Speed (MT/s)				
1 DIMM Per Channel	2133 MT/s	2133 MT/s	2133 MT/s	2133 MT/s
2 DIMM Per Channel	2133 MT/s	2133 MT/s	2133 MT/s	2133 MT/s
HPE Server Memory Speed (MT/s): Intel Xeon®Platinum 81xx/61xx Processors *				
1 DIMM Per Channel	2666 MT/s	2666 MT/s	2666 MT/s	2666 MT/s
2 DIMM Per Channel	2666 MT/s	2666 MT/s	2666 MT/s	2666 MT/s
HPE Server Memory Speed (MT/s): Intel Xeon®Platinum 41xx/51xx Processors *				
1 DIMM Per Channel	2400 MT/s	2400 MT/s	2400 MT/s	2400 MT/s
2 DIMM Per Channel	2400 MT/s	2400 MT/s	2400 MT/s	2400 MT/s

Memory

HPE Server Memory Speed (MT/s): Intel Xeon®Platinum 31xx Processors *				
1 DIMM Per Channel	2133 MT/s	2133 MT/s	2133 MT/s	2133 MT/s
2 DIMM Per Channel	2133 MT/s	2133 MT/s	2133 MT/s	2133 MT/s

NOTE: The maximum memory speed is a function of the memory type, memory configuration, and processor model.
For details on the HPE Server Memory speed, visit: <https://www.hpe.com/docs/memory-speed-table>.

DIMM Type	Load Reduced (LRDIMM)	
HPE SKU P/N	815101-B21	815102-B21
SKU Description	HPE 64GB (1x64GB) Quad Rank x4 DDR4-2666 CAS-19-19-19 Load Reduced Smart Memory Kit	HPE 128GB (1x128GB) Octal Rank x4 DDR4-2666 CAS-22-19-19 3DS Load Reduced Memory Kit
DIMM Rank ->	Quad Rank (4R)	Octal Rank (8R)
DIMM Capacity ->	64GB	128GB
Voltage	1.2V	1.2V
DRAM depth [bit]	2G	2G
DRAM Width [bit]	x4	x4
DRAM Density	8Gb	8Gb
CAS Latency	19-19-19	22-19-19
DIMM Native Speed (MT/s)	2666	2666

Intel Xeon® Platinum 81xx/61xx Processors Officially Supported Memory Speed (MT/s)		
1 DIMM Per Channel	2666 MT/s	2666 MT/s
2 DIMM Per Channel	2666 MT/s	2666 MT/s

Intel Xeon® Gold/Silver 41xx/51xx Processors Officially Supported Memory Speed (MT/s)		
1 DIMM Per Channel	2400 MT/s	2400 MT/s
2 DIMM Per Channel	2400 MT/s	2400 MT/s

Intel Xeon® Bronze 31xx Processors Officially Supported Memory Speed (MT/s)		
1 DIMM Per Channel	2133 MT/s	2133 MT/s
2 DIMM Per Channel	2133 MT/s	2133 MT/s

HPE Server Memory Speed (MT/s): Intel Xeon® Platinum 81xx/61xx Processors *		
1 DIMM Per Channel	2666 MT/s	2666 MT/s
2 DIMM Per Channel	2666 MT/s	2666 MT/s

HPE Server Memory Speed (MT/s): Intel Xeon® Gold/Silver 41xx/51xx Processors *		
1 DIMM Per Channel	2400 MT/s	2400 MT/s
2 DIMM Per Channel	2400 MT/s	2400 MT/s

HPE Server Memory Speed (MT/s): Intel Xeon® Bronze 31xx Processors *		
1 DIMM Per Channel	2133 MT/s	2133 MT/s
2 DIMM Per Channel	2133 MT/s	2133 MT/s

NOTE: The maximum memory speed is a function of the memory type, memory configuration, and processor model.
For details on the HPE Server Memory speed, visit: <https://www.hpe.com/docs/memory-speed-table>.

Standard and Maximum Memory Capacity (Pre-configured Models)

Pre Configured Models	Standard Memory	Maximum Memory Plus Optional Memory	Standard Memory Replaced with Optional Memory
3104	8GB (1x8 GB RDIMM SR)	192 GB (24x 8 GB)	3072 GB (24x 128 GB)
3106	16 GB (1x16 GB RDIMM SR)	384 GB (24x 16 GB)	3072 GB (24x 128 GB)
4110	16 GB (1x16 GB RDIMM SR)	384 GB (24x 16 GB)	3072 GB (24x 128 GB)

Memory

4114	32 GB (2x16 GB RDIMM SR)	384 GB (24x 16 GB)	3072 GB (24x 128 GB)
5118	32 GB (2x16 GB RDIMM SR)	384 GB (24x 16 GB)	3072 GB (24x 128 GB)

NOTE: The 13th – 24th DIMM support requires installation of the second processor.

DDR4 memory options part number decoder

NOTE: Capacity references are rounded to the common gigabyte (GB) values.

- 8GB = 8,192 MB
- 16GB = 16,384 MB
- 32GB = 32,768 MB
- 64GB = 65,536 MB
- 128 GB = 131,072 MB

For more information on memory, please see the Memory QuickSpecs: [HPE DDR4 SmartMemory](#).

Storage

4 LFF non-hot-plug drive model:
Tower – shown with the tower feet.
1 x 4 LFF SAS/SATA non-hot-pluggable
HDD/SSD Cage Kit in Box 3.
HDD Cage Blank in Box 2.
Media Bay Blanks (2) and DVD blank (1)
in Box 1.

8 LFF non-hot-plug drive + media bay
(2) and DVD (1) model:
Tower – shown with the tower feet.
1 – 2 4 LFF SAS/SATA non-hot-
pluggable HDD/SSD Cage Kit
HH Media Bay up to 2 and/or 1 DVD in
Box 1

12 LFF non-hot-plug drive model:
Tower – shown with the tower feet.
1 – 3 4 LFF SAS/SATA non-hot-
pluggable HDD/SSD Cage Kit (s)

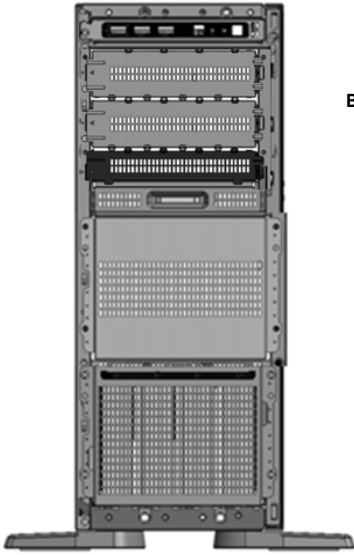

Box 1

Box 2

Box 3



Box 1

Box 2

Box 3

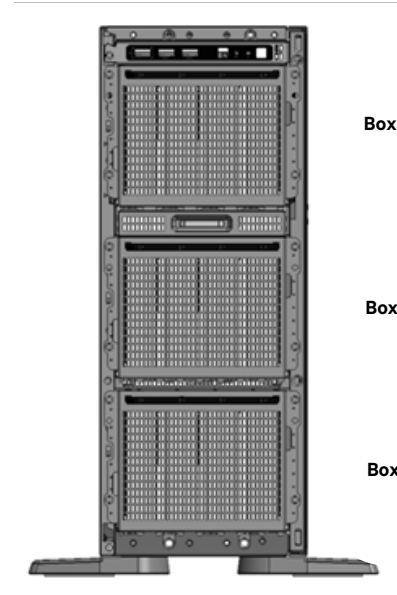

Box 1

Box 2

Box 3

Storage

4 LFF hot-plug drive model:
Tower – shown without the tower feet.
1 x 4 LFF SAS/SATA hot-pluggable
HDD/SSD Cage Kit in Box 3.
HDD Cage Blank in Box 2.
Media Bay Blanks (2) and DVD blank (1)
in Box 1.

8 LFF hot-plug drives + media bay (2)
and DVD (1) model:
Tower – shown with the tower feet.
1 – 2 4 LFF SAS/SATA hot-pluggable
HDD/SSD Cage Kit (2)
HH Media Bay up to 2 and/or 1 DVD in
Box 1.

12 LFF hot-plug drive model:
Tower – shown with the tower feet.
1 – 3 4 LFF SAS/SATA hot-pluggable
HDD/SSD Cage Kit (s)

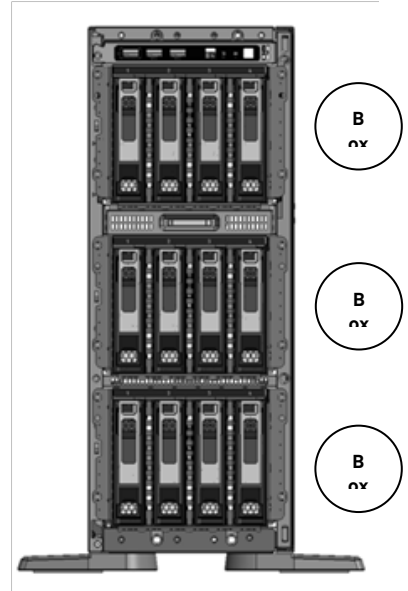
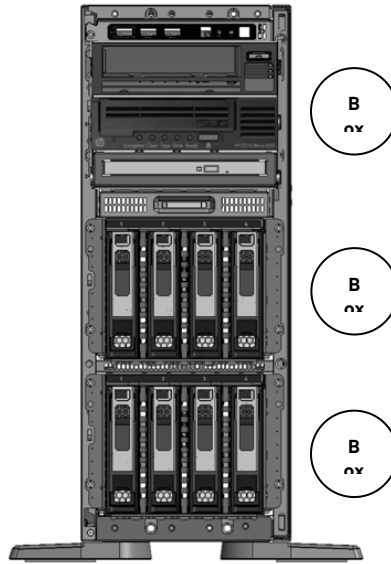
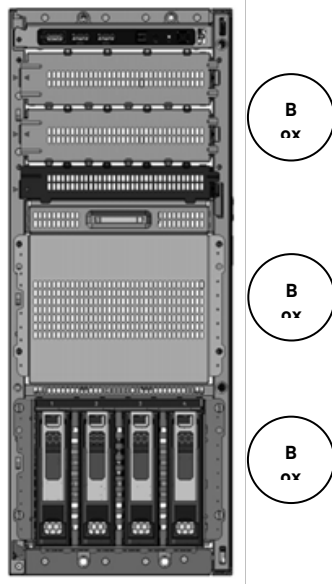

Storage

8 SFF hot-plug drive model:

Tower – shown without the tower feet.

1 x 8 SFF SAS/SATA hot-pluggble

HDD/SSD Cage Kit in Box 3.

HDD Cage Blank in Box 2.

Media Bay Blanks (2) and DVD blank (1) in Box 1.

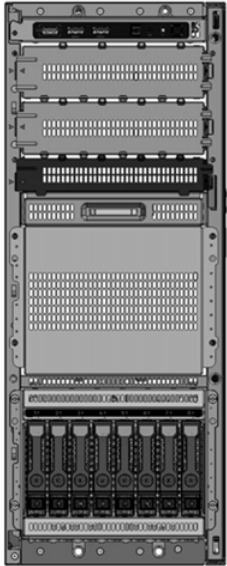

16 SFF hot-plug drives + media bay (2) and DVD (1) model:

Tower – shown without the tower feet.

1 – 2 x 8 SFF SAS/SATA hot-pluggble

HDD/SSD Cage Kit (2)

HH Media Bay up to 2 and/or 1 DVD in Box 1.



Storage

24 SFF hot-plug drive model:
Tower – shown without the tower feet.
1 – 3 8 SFF SAS/SATA hot-pluggable
HDD/SSD Cage Kit (s).

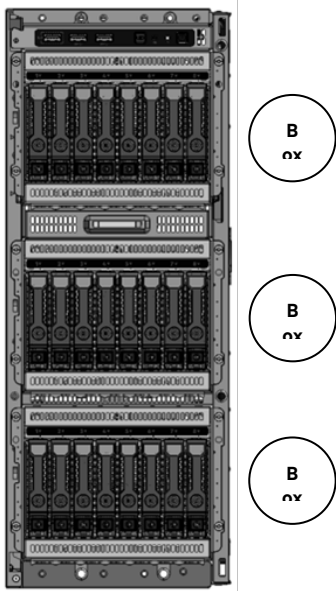

16 SFF hot-plug drive + 8 NVMe SSD
model:
Tower – shown without the tower feet.
1 – 2 8 SFF SAS/SATA hot-pluggable
HDD/SSD Cage Kit (s)
1x 8 SFF NVMe Express Bay Kit in Box 2
for optional NVMe PCIe SSD, up to 8.

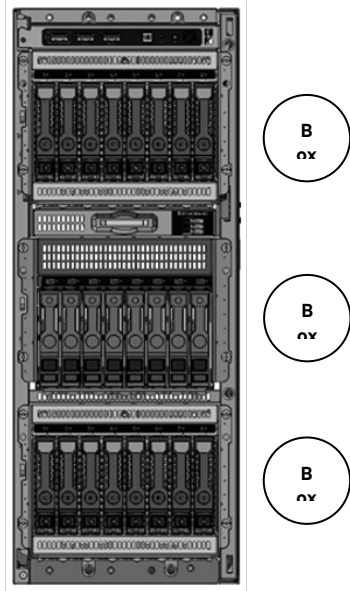

8 SFF hot-plug drive + 8 NVMe SSD +
media bay (2) and DVD (1) model:
Tower – shown without the tower feet.
1x 8 SFF SAS/SATA hot-pluggable
HDD/SSD Cage Kit
1x 8 SFF NVMe Express Bay Kit in Box 2
for optional NVMe PCIe SSD, up to 8
HH Media Bay up to 2 and/or 1 DVD in
Box 1.

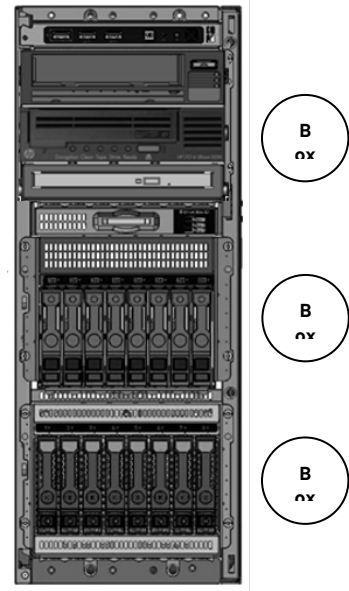

Technical Specifications

System Unit

Dimensions	46.25 (H) x 64.8 (D) x 17.4 (W) cm	Tower
	18.2 (H) x 25.51 (D) x 6.85 (W) in	
	17.4 (H/4U) x 64.8 (D) x 44.5 (W) cm	Rack – System only
	6.85 (H) x 25.51 (D) x 17.52 (W) in	
	4.445 (H/1U) x 69.2 (D/without CMA. Tower-to-Rack Conversion Kit (1U) Depth with CMA: 83.5) x 45.2 (W) cm	
Weight (approximate)	21 kg	Minimum: 8 SFF or 4LFF chassis with 1x SFF or LFF HDD and HDD blanks, 1x HDD Drive Cage blank, 2x Media Bay blanks, 1x DVD bay blank, 1x processor including standard heatsink, 2 DIMMs, 1x power supply (plus blank), 1x Flexible Smart Array (AROC), Cables for the above.
	46.30 lb	
	42 kg	Maximum – fully loaded system: 24 SFF or 12 LFF hard drives, 4 DW GPUs (or 8 standard PCIe expansion cards), 2x processors including 2 performance heatsinks, 24 DIMMs, 2x power supplies, 1x Flexible Smart Array (AROC), Cables for the above.
	92.59 lb	
Input Requirements (per power supply)	Rated Line Voltage	100 to 120 VAC 200 to 240 VAC
BTU Rating	Maximum	For 800W Power Supply: 3067 BTU/hr (at 100 VAC), 2958 BTU/hr (at 200 VAC), 2949 BTU/hr (at 240 VAC) For 500W Power Supply: 1902 BTU/hr (at 100 VAC), 1840 BTU/hr (at 200 VAC), 1832 BTU/hr (at 240 VAC) For 1600W Power Supply: 5918 BTU/hr (at 200 VAC), 5884 BTU/hr (at 240 VAC)
Power Supply Output (per power supply)	Rated Steady-State Power	For 1600W Power Supply: 1600W (at 240 VAC), 1600W (at 240 VAC) For 800W Power Supply: 800W (at 100 VAC), 800W (at 240 VAC), 800W (at 240 VAC) For 500W Power Supply: 500W (at 100 VAC), 500W (at 240 VAC), 500W (at 240 VAC)
	Maximum Peak Power	For 1600W Power Supply: 1600W (at 200 to 240 VAC), 1600W (at 240 VAC) For 800W Power Supply: 800W (at 100 to 127 VAC), 800W (at 200 to 240 1VAC), 800W (at 240 VAC) For 500W Power Supply: 500W (at 100 to 127 VAC), 500W (at 200 to 240 VAC), 500W (at 240 VAC)
System Inlet Temperature	Standard Operating Temperature	10° to 35°C (50° to 95°F) at sea level with an altitude derating of 1.0°C per every 305 m (1.8°F per every 1000 ft) above sea level to a maximum of 3050 m (10,000 ft), no direct sustained sunlight. Maximum rate of change is 20°C/hr (36°F/hr). The upper limit and rate of change may be limited by the type and number of options installed.
	Extended Ambient Operating Temperature	System performance during standard operating support may be reduced if operating with a fan fault or above 30°C (86°F). For approved hardware configurations, the supported system inlet range is extended to be: 5° to 10°C (41° to 50°F) and 35° to 40°C (95° to 104°F) at sea level with an altitude derating of

Technical Specifications

		1.0°C per every 175 m (1.8°F per every 574 ft) above 900 m (2953 ft) to a maximum of 3050 m (10,000 ft). The approved hardware configurations for this system are listed at the URL: http://www.hpe.com/servers/ashrae
		For approved hardware configurations, the supported system inlet range is extended to be: 40° to 45°C (104° to 113°F) at sea level with an altitude derating of 1.0°C per every 125 m (1.8°F per every 410 ft) above 900 m (2953 ft) to a maximum of 3050 m (10,000 ft). The approved hardware configurations for this system are listed at the URL: http://www.hpe.com/servers/ashrae
		System performance may be reduced if operating in the extended ambient operating range or with a fan fault.
Relative Humidity (non-condensing)	Non-operating	-30° to 60°C (-22° to 140°F). Maximum rate of change is 20°C/hr (36°F/hr).
	Operating	8% to 90% - Relative humidity (Rh), 28°C maximum wet bulb temperature, non-condensing.
	Non-operating	5 to 95% relative humidity (Rh), 38.7°C (101.7°F) maximum wet bulb temperature, non-condensing..
Altitude	Operating	3050 m (10,000 ft). This value may be limited by the type and number of options installed. Maximum allowable altitude change rate is 457 m/min (1500 ft/min).
	Non-operating	9144 m (30,000 ft). Maximum allowable altitude change rate is 457 m/min (1500 ft/min).
Acoustic Noise	Listed are the declared A-Weighted sound power levels (L_{WAd}) and declared average bystander position A-Weighted sound pressure levels (L_{pAm}) when the product is operating in a 23°C ambient environment. Noise emissions were measured in accordance with ISO 7779 (ECMA 74) and declared in accordance with ISO 9296 (ECMA 109). The listed sound levels apply to standard shipping configurations. Additional options may result in increased sound levels, for example, higher-end graphic processing units (GPU), NVMe SSD or NVMe M.2. Please have your HPE representative provide information from the HPE EMESC website for further technical details regarding the configurations listed below.	
	Idle	
	LWAd	4.0 B Entry 3.9 B Base 4.4 B Perf
	LpAm	28 dBA Entry 27 dBA Base 31 dBA Perf
	Operating	
	LWAd	4.2 B Entry 4.3 B Base 4.4 B Perf
	LpAm	29 dBA Entry 30 dBA Base 32 dBA Perf

NOTE: Acoustics levels presented here are generated by the test configuration only. Acoustics levels will vary depending on system configuration. Values are subject to change without notification and are for reference only.

Technical Specifications

NOTE: Product conformance to cited product specifications is based on sample (type) testing, evaluation, or assessment. This product or family of products is eligible to bear the appropriate compliance logos and statements.

NOTE: The Listed sound levels apply to standard shipping configurations. Additional options may result in increased sound levels, for example, higher-end graphic processing units (GPU), NVMe SSD or NVMe M.2.

Emissions Classification (EMC) – Regulatory Information

To view the regulatory information for your product, view the Safety and Compliance Information for Server, Storage, Power, Networking, and Rack Products, available at the Hewlett Packard Enterprise Support Center:

<http://www.hpe.com/support/Safety-Compliance-EnterpriseProducts>

Environment-friendly Products and Approach - End-of-life Management and Recycling

Hewlett Packard Enterprise offers **end-of-life product return, trade-in, and recycling programs** in many geographic areas, for our products. Products returned to Hewlett Packard Enterprise will be recycled, recovered or disposed of in a responsible manner.

The EU WEEE directive (2002/95/EC) requires manufacturers to provide treatment information for each product type for use by treatment facilities. This information (product disassembly instructions) is posted on the Hewlett Packard Enterprise web site. These instructions may be used by recyclers and other WEEE treatment facilities as well as Hewlett Packard Enterprise OEM customers who integrate and re-sell Hewlett Packard Enterprise equipment.

Summary of Changes

Date	Version History	Action	Description of Change
03-Dec-2018	Version 11	Added	New SSD options, new storage CNAs, RDX cartridges in the newly added RDX option category. TPM1.2 FIO part added.
15-Oct-2018	Version 10	Changed	Core Options and Additional Options were Updated. SKU descriptions updated. Obsolete SKUs were removed from the QuickSpecs.
01-Oct-2018	Version 9	Added	Added new NVIDIA Quadro GV100 and NVLink Bridge support Added new SFF and LFF SSD models Added S100i OS limitation under the OS section
		Changed	Updated OS support section Updated header on page#18, 19 & 67 to ML350 Gen10 Updated the pre-configured SKU model section, removing the note in the sub-entry SKU Updated the note related to internal media drive support kit & RDX
06-Aug-2018	Version 8	Added	Added new NVIDIA Quadro P2000 GPU support. Added new SFF SATA SSD models. Added new 100Gb adapter. Added cabling requirement for S100i/embedded SATA controller config.
		Changed	Configuration Information – Factory Integrated Models, Core Options, Additional Options were revised.
04-Jun-2018	Version 7	Added	Added the new P824i-p info in the controller section. Added new RI SFF SSD in the SSD section. Added 4TB NVMe SSD and revise the max. NVMe capacity supported.
		Changed	Configuration Information – Factory Integrated Models, Core Options, Additional Options, and Memory were revised.
		Removed	Obsolete SKUs were removed from the QuickSpecs
02-Apr-2018	Version 6	Added	Added one new Solution SKU to pre-configured models. Added new supported SSDs. Added IST support in the what's new section.
		Removed	Removed discontinued NHP/raw HDDs.
		Changed	Power cord support in pre-config models was revised. CTO Rack model support was revised. Internal LTO/RDX along with fan redundant kit support was revised.
05-Feb-2018	Version 5	Added	Added NVIDIA Quadro P4000 GPU support. Added 12TB SAS LFF HDD. Added new LTO-8 tape drive support. Added PCIe Accelerator option category, new StoreFabric CNA, etc. Added notes in embedded NIC support. Added notes in Smart Array controller/s to select cables.
		Changed	Removed hyperlink to Cable Matrix but directed to User Guide.
04-Dec-2017	Version 4	Added	Added 128GB DDR4 LRDIMM support. Added new 12TB SATA LFF HDD support – max. 144TB in LFF config.
		Changed	Updated the Smart Storage Battery with the new part number. Updated SW RAID S100i Linux OS support note.
		Removed	Removed the old Smart Storage Battery part.
23-Oct-2017	Version 3	Changed	Memory speed table was updated to display the 61XX processors running at 2666MT/s.
16-Oct-2017	Version 2	Added	Added HPE Support Services.
25-Sep-2017	Version 1	New	New QuickSpecs.

Summary of Changes



[Sign up for updates](#)



**Hewlett Packard
Enterprise**

© Copyright 2018 Hewlett Packard Enterprise Development LP. The information contained herein is subject to change without notice. The only warranties for Hewlett Packard Enterprise products and services are set forth in the express warranty statements accompanying such products and services. Nothing herein should be construed as constituting an additional warranty. Hewlett Packard Enterprise shall not be liable for technical or editorial errors or omissions contained herein.

Intel® and Xeon® are registered trademarks of Intel Corporation in the U.S. and other countries. Microsoft®, Windows®, and Windows Server® are U.S. registered trademarks of the Microsoft group of companies.
For hard drives, 1GB = 1 billion bytes. Actual formatted capacity is less

a00021852enw - 16055 - Worldwide - V11 - 3-December-2018